

POLARIS XPEDITION

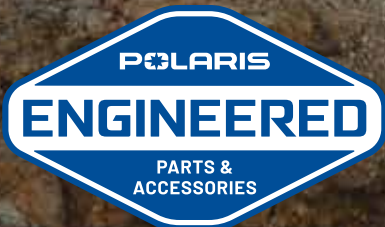

2025

**ACCESSORIES,
MAINTENANCE & APPAREL**

INTERNATIONAL VERSION

EXPERIENCE ELEVATED PERFORMANCE

Break away from the crowd with family, friends and all of your gear to reach deep into the backcountry. Get ready for endless adventure in a capable, comfortable off-road vehicle that adapts to your lifestyle.



The next generation of Lock & Ride technology lets you customize your vehicle with easy-to-install storage solutions to pack everything you need for your adventure. Plus, the new storage system lets you quickly adapt your vehicle with limitless storage configurations to best meet your riding needs no matter what adventure lies ahead.

08 NORTHSTAR

14 ACCESSORIES

- 20 WINDSHIELDS & REAR PANELS
- 22 DOORS
- 24 CAB COMFORT
- 26 VEHICLE PROTECTION
- 28 STORAGE
- 34 OVERLANDING/CAMPING
- 35 RECOVERY
- 36 WINCHES, PLOWS & TRACKS
- 38 LIGHTING
- 42 CONNECTED TECHNOLOGY
- 44 HUNT
- 46 COOLERS
- 48 WHEELS & TIRES
- 54 TIRE SEALANT & TRAILERING

56 MAINTENANCE & GARAGE

- 58 MAINTENANCE PARTS & FLUIDS
- 60 OIL & LUBRICANTS
- 62 GARAGE ACCESSORIES
- 64 BATTERY CHARGERS & SERVICE PARTS
- 66 POLARIS POWER

68 APPAREL

- 69 POLARIS XPEDITION APPAREL
- 69 OUTERWEAR & HATS
- 70 CASUALWEAR
- 71 HELMETS & GOGGLES

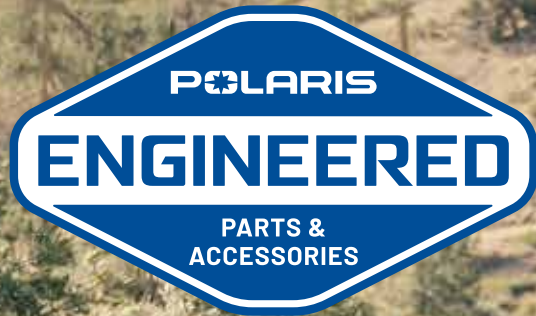

DESIGNED

by the people who designed your vehicle.

TESTED

in the field so you ride with 100% confidence.

TRUSTED

70 years in the business. The #1 name in off-road.

KEEP YOUR
STANDARDS HIGH.
WE DO.



**WE HOLD OUR PARTNERS
TO THE SAME STANDARDS**

Sharing an outdoor adventure with a companion or two gives your experience its very own energy. When we meet another brand that builds and tests their products with the same rigor as we do, a kinship forms. So we give them an exclusive partner badge and invite them along for the ride. It's another way we bring you the best options for customizing your Polaris vehicle without compromise. How better to send you and your crew out into the world?



ENGINEERED FOR MORE

ULTIMATE ADVENTURE READINESS

Unlock experiences beyond the trailhead with Polaris XPEDITION. Developed and tested alongside the vehicle, Polaris Engineered accessories are designed for seamless integration and simple installation so you can take your adventure further.

GO FURTHER



PLUG & PLAY ELECTRICAL

A revolution in electrical accessory integration, the Polaris PULSE Electrical System allows for a simple plug & play approach for adding power to Polaris Engineered accessories.

P. 25

PRO HD SERIES HEAVY DUTY WINCHES

INTEGRATED, PRE-WIRED WINCH MOUNT

Designated mounting points and pre-wired connectors create a perfect fit in the strongest location for attaching a Polaris Engineered winch. With wiring built right into the vehicle, we made winch installation simple.

P. 36

EXPLORE ALL YEAR-ROUND

PRO SHIELD CAB SYSTEMS

MAXIMIZED RIDER COMFORT

Add a new level of interior comfort with a Pro Shield Cab System, which has been tested to military standards. Seal out dust, water and noise with a windshield, rear panel and full doors.

P. 20

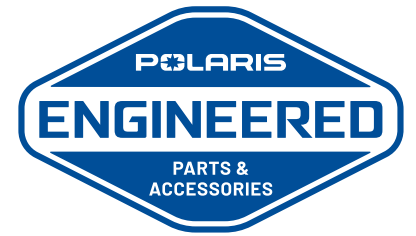
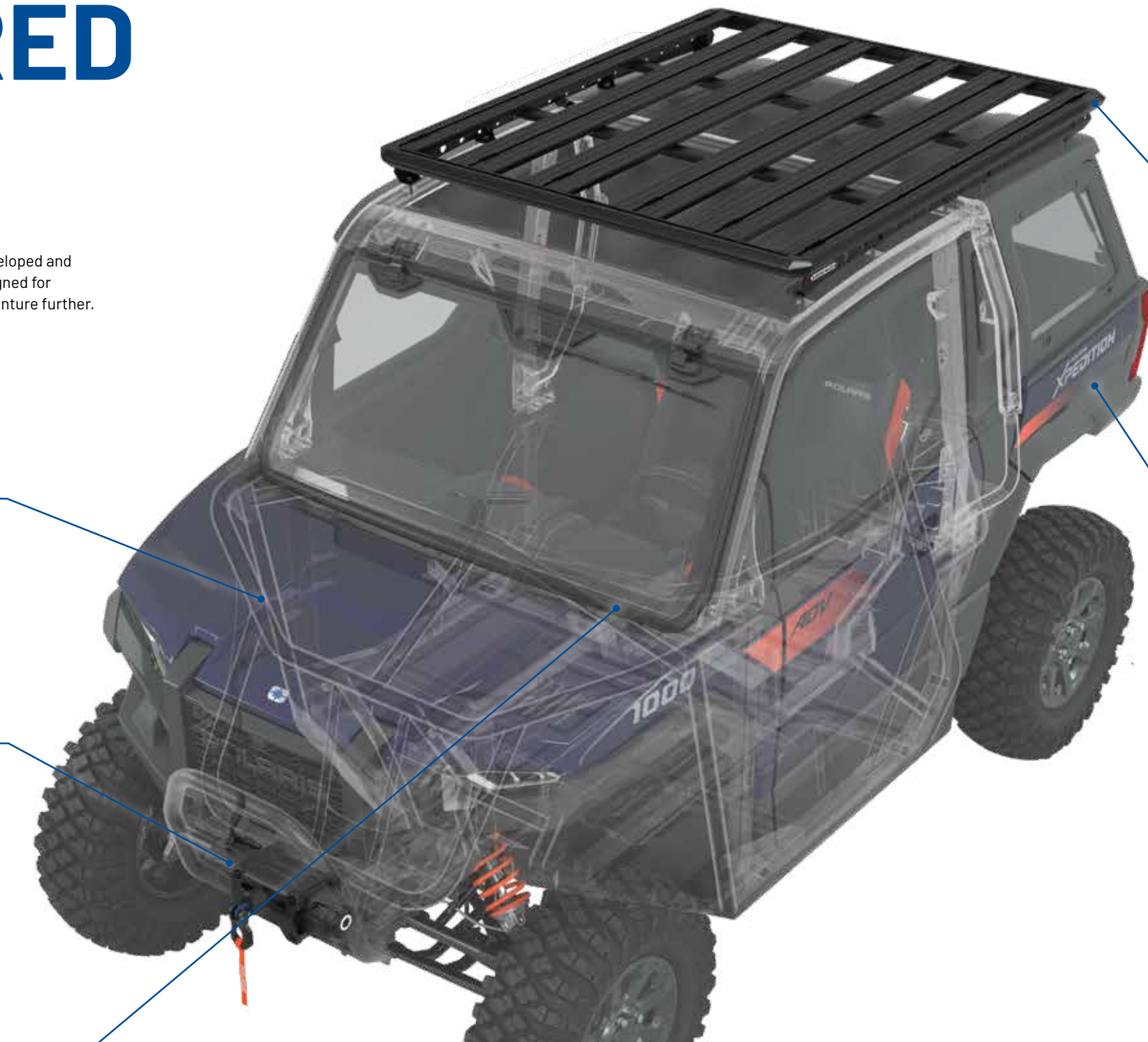

MAXIMIZE OUTDOOR EXPERIENCES



BRING IT ALL. BRING IT ON.*

Rhino-Rack® roof rack and bed rack solutions offer 40% more storage capacity so you never have to leave tools or gear behind.

P. 32

*Always read and follow the owner's manual and on-vehicle labels for prohibited items.



ADAPTABLE STORAGE SOLUTIONS

The next generation of the Polaris Lock & Ride platform brings with it an entirely new system of purpose-built accessories and attachments. This means you can go further, push harder and do more than ever before.

P. 29



EASY ON & OFF

Adapt to your needs and environment with exclusive toolless, easy on/off Lock & Ride components.

P. 20

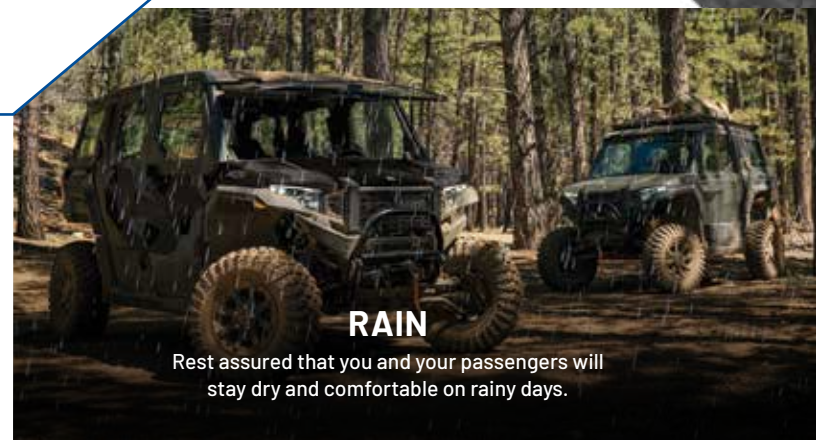

RAIN

Rest assured that you and your passengers will stay dry and comfortable on rainy days.



SNOW

Keep cold wind and snow out during the winter months.



DUST

Reduce dust swirl in the cab of your vehicle for increased comfort and visibility.

YEAR-ROUND COMFORT

POLARIS XPEDITION NORTHSTAR

Be in control of your comfort with a standard Pro Shield cab system, heat, air conditioning and more. A NorthStar trim helps you finish whatever task you set out to do, no matter the weather conditions.



ACCESSORIZE IT

PROTECTION

Protect the front and rear of your vehicle from obstacles you may encounter while off-roading.

P. 26

STORAGE

Leave nothing behind with the limitless customization of Lock & Ride MAX and Rhino-Rack® storage solutions.

P. 28

LIGHTING

Extend the day with premium, easy-to-install lighting from RIGID® and Pro Armor.

P. 38

WHEELS & TIRES

Choose from multiple terrain-specific tires, then add style with five lug wheel options.

P. 48

UPGRADE YOUR NORTHSTAR

CUSTOMIZE FOR YOUR RIDING STYLE

You've got the essentials straight from the factory, but why stop there? Get the most out of your NorthStar with additional Polaris Engineered accessories built to fit your riding needs.



**POLARIS XPEDITION
XP NORTHSTAR
(2-SEAT / 5-SEAT)**



**POLARIS XPEDITION
ADV NORTHSTAR
(2-SEAT / 5-SEAT)**

BOTH COME STANDARD WITH:

Heating & Air Conditioning System
JBL® Audio System
Full Glass Tip Out Windshield with Wiper/Washer System
Full Poly Doors with Power Windows

Glass Rear Panel (XP only) / Glass Rear Liftgate (ADV only)
Rear Glass Side Panels (ADV only)
Polaris HD 2,041 kg Winch
Sport Roof with Premium Liner & Dome Light

LED Headlights
Pro Armor 30" Crawler XP Tires
Locking Doors
Weatherproof Convex Rearview Mirror



	PRODUCT	PART NUMBER (2-SEAT / 5-SEAT)	PAGE
MUST HAVES	Adjustable Folding Side Mirrors	2884491	P. 24
	HD Extreme Kick-Out Rock Sliders	2884495-458 / 2884497-458	P. 26
	Rear Bumper	2884498-458	P. 26
	RIGID® SR-Series 81 cm Combo LED Light Bar	2884299	P. 41
ADVENTURE	Hood Rack	2889387	P. 30
	Rhino-Rack® Roof Rack	2889590 / 2889237	P. 32

**SHOP FOR YOUR RIDING NEEDS WITH
OUR ACCESSORY PACKAGES**
SEE FOLLOWING PAGES



TRAIL PACKAGE

For the casual riders looking to explore the trails through various landscapes. Featuring premium RIGID® lighting, a spare tire carrier, vehicle protection, Rhino-Rack® accessories and Pro Armor Attack 2.0 tires.

- 2889331-458 HD Rear Bumper: P. 26
- 2884495-458 HD Extreme Kick-Out Rock Sliders, 2-Seat: P. 26
- 2884714 Front A-Arm Guards: P. 27
- 2884715 Rear A-Arm Guards: P. 27
- 2889336-458  Spare Tire Carrier: P. 30
- 2889622  Bed Rail Kit: P. 31

- 2890894  D-Rings: P. 31
- 2889237 Rhino-Rack® Roof Rack, Large: P. 32
- 2889451 Rhino-Rack® Roof Rack Mount, Large: P. 32
- 2889881 Rhino-Rack® 200 L Luggage Bag: P. 33
- 2889533 Rhino-Rack® High-Lifting Jack Mount: P. 33
- 2889508 91.4cm High-Lifting Jack: P. 35

- 2890646  MAXTRAX® Traction Boards & Mounts: P. 35
- 2890542 Recovery Shackles: P. 35
- 2889731 RIGID® SR-M-Series Pro Driving LED Lights: P. 40
- 2884299 RIGID® SR-Series 81cm Combo LED Light Bar: P. 41
- 2889643 Front Roof Light Bar Mounts: P. 41
- 2889892 Front Roof Light Bar Harness: P. 41

- 5416345 Pro Armor Spare Tire: Attack 2.0, 30": P. 50
- 1525420 Pro Armor Spare Wheel: 5304 Beadlock, 15": P. 52
- 2889994 Pro Armor Wheel & Tire Set: 5304 Beadlock & Attack 2.0, 30": P. 53

Shown on ADV NorthStar 2-Seat. Applicable to all models with adjustments.

HUNT PACKAGE

For the big gamers and the small gamers, both searching for their next trophy. Featuring Rhino-Rack® roof and bed racks, a Kolpin gun boot, premium lighting, a NorthStar cooler and a hood rack.



- 2884498-458 Rear Bumper: P. 26
- 2884496-458 Low Profile Rock Sliders, 2-Seat: P. 26
- 2889387 Hood Rack - Stock Bumper: P. 30
- 2889590 Rhino-Rack® Roof Rack, Small: P. 32
- 2889450 Rhino-Rack® Roof Rack Mount, Small: P. 32
- 2889590 Rhino-Rack® Rear Bed Rack: P. 32

- 2889453 Rhino-Rack® Rear Bed Rack Mount: P. 32
- 2889529 Rhino-Rack® Spare Tire Holder: P. 33
- 2889327 Rhino-Rack® Gun Mounting Bracket (2): P. 33
- 2889533 Rhino-Rack® High-Lifting Jack Mount: P. 33
- 2889527 Rhino-Rack® Eyelet Tie-Downs: P. 33
- 2889531 Rhino-Rack® Corner Cargo Brackets: P. 33

- 2889508 91.4cm High-Lifting Jack: P. 35
- 2884299 RIGID® SR-Series 81cm Combo LED Light Bar: P. 41
- 2889643 Front Roof Light Bar Mounts: P. 41
- 2889892 Front Roof Light Bar Harness: P. 41
- 2882036 Kolpin Stronghold Gun Boot XL (2): P. 44
- 2636942 Auto-Latch Mount (2): P. 44

- 2883425 Polaris NorthStar 57 L Cooler: P. 46
- 2883424 Polaris NorthStar 28 L Cooler: P. 46
- 5416345 Pro Armor Spare Tire: Attack 2.0, 30": P. 50
- 1524038 Pro Armor Spare Wheel: 5302 Beadlock, 15": P. 52
- 2889934 Pro Armor Wheel & Tire Set: 5302 Beadlock & Attack 2.0, 30": P. 53

Shown on XP NorthStar 2-Seat. Applicable to all models with adjustments.



Never transport a loaded firearm. Verify firearm is unloaded prior to mounting. Please refer to local laws and regulations regarding the requirements for the legal transport of firearms.



OVERLAND PACKAGE

For the ultimate adventurers wishing to get out into nature or camp out of their vehicle. Featuring a Rhino-Rack® roof rack, rooftop tent, recovery gear, vehicle protection and premium lighting.

- 2891036 Glass Windshield Wiper Kit, Rear: P. 20
- 2884491 Adjustable Folding Side Mirrors: P. 24
- 2890545 RAM® Phone Mount: P. 24
- 2884497-458 HD Extreme Kick-Out Rock Sliders, 5-Seat: P. 26
- 2891009-458 HD Front Bumper: P. 26
- 2889331-458 HD Rear Bumper: P. 26
- 2884503 Hood Rack - HD Bumper: P. 30
- 2889336-458  Spare Tire Carrier: P. 30

- 2889623  Rear Floor Rail Kit: P. 31
- 2890894  D-Rings: P. 31
- 2889478 Rear Window Molle Panels: P. 31
- 2889237 Rhino-Rack® Roof Rack, Large: P. 32
- 2889452 Rhino-Rack® Roof Rack Mount, Large: P. 32
- 2890560 Rooftop Tent: P. 34
- 2890646  MAXTRAX® Traction Boards & Mounts: P. 35
- 2890542 Recovery Shackles: P. 35

- 2884839 Polaris Pro HD High-Mounted 2,722kg Winch: P. 36
- 2883126 RIGID® D-Series Pro Flood LED Lights: P. 40
- 2889731 RIGID® SR-M-Series Pro Driving LED Lights: P. 40
- 2889567 RIGID® RDS SR-Series 127cm Curved Single-Row Light Bar: P. 41
- 2889591 127cm Light Bar Harness: P. 41
- 2889820 Front HD Bumper Cube Light Mounts: P. 41
- 2889885 Front HD Bumper Cube Light Harness + Switch: P. 41

- 2884783 RIGID® Scene Lights: P. 41
- 2883968 Polaris NorthStar 14 L Cooler: P. 47
- 5416397 Pro Armor Spare Tire: Crawler XG, 30": P. 50
- 1525420 Pro Armor Spare Wheel: 5304 Beadlock, 15": P. 52
- 2889995 Pro Armor Wheel & Tire Set: 5304 Beadlock & Crawler XG, 30": P. 53



Shown on ADV NorthStar 5-Seat. Applicable to all models with adjustments.

KAYAK PACKAGE

For the kayakers, canoers, paddle boarders or other watersport enthusiasts. Featuring a Rhino-Rack® roof rack, kayak and fishing rod holders, a half windshield, skeleton half doors and a NorthStar cooler.



- 2884411  Half Windshield - Hard Coat Poly: P. 21
- 2884717 Skeleton Half Doors, Front: P. 23
- 2884399 Skeleton Half Doors, Rear: P. 23
- 2884491 Adjustable Folding Side Mirrors: P. 24
- 2889357-458 Low Profile Rock Sliders, 5-Seat: P. 26

- 2889478 Rear Window Molle Panels: P. 31
- 2889622  Bed Rail Kit: P. 31
- 2890894  D-Rings: P. 31
- 2889237 Rhino-Rack® Roof Rack, Large: P. 32
- 2889452 Rhino-Rack® Roof Rack Mount, Large: P. 32

- 2889883 Rhino-Rack® J-Style Kayak Holder: P. 33
- 2889884 Rhino-Rack® Accessory Bars: P. 33
- 2889729 Rhino-Rack® Fishing Rod Holder: P. 33
- 2884299 RIGID® SR-Series 81cm Combo LED Light Bar: P. 41
- 2889643 Front Roof Light Bar Mounts: P. 41

- 2889892 Front Roof Light Bar Harness: P. 41
- 2883424 Polaris NorthStar 28 L Cooler: P. 46
- 2889935 Pro Armor Wheel & Tire Set: 5302 Beadlock & Crawler XG, 30": P. 53





Shown on ADV Ultimate 5-Seat. Applicable to all models with adjustments. Activity items shown are not sold by Polaris.



UTILITY PACKAGE

For the DIYers and landowners needing to get the job done, while still having fun. Featuring Lock & Ride MAX storage accessories, a hood rack, a heater & defrost kit, upper doors and a poly rear panel.

- 2884409  Full Vented Windshield - Hard Coat Poly: P. 21
- 2889344 Rear Panel - Poly: P. 21
- 2884398 Canvas Upper Doors, Front: P. 23
- 2884491 Adjustable Folding Side Mirrors: P. 24
- 2889734 Heater & Defrost Kit: P. 24
- 2884496-458 Low Profile Rock Sliders, 2-Seat: P. 26
- 2889387 Hood Rack - Stock Bumper: P. 30
- 2889409-458 Headache Rack: P. 30

- 2884712  Rear Storage Box: P. 30
- 2890091-458  Bed Extender: P. 30
- 2889468-458  Cross Bed Bar: P. 30
- 2890894  D-Rings: P. 31
- 2889590 Rhino-Rack® Roof Rack, Small: P. 32
- 2889450 Rhino-Rack® Roof Rack Mount, Small: P. 32
- 2889528 Rhino-Rack® Multi-Purpose Tool Holder (2): P. 33
- 2889527 Rhino-Rack® Eyelet Tie-Downs: P. 33

- 2884299 RIGID® SR-Series 81cm Combo LED Light Bar: P. 41
- 2884783 RIGID® Scene Lights: P. 41
- 2889643 Front Roof Light Bar Mounts: P. 41
- 2889892 Front Roof Light Bar Harness: P. 41
- 2884107  Kolpin Rhino Grip Pro: P. 45
- 2889996 Pro Armor Wheel & Tire Set: 5304 Beadlock & Harvester, 30": P. 53

BE PREPARED FOR SNOW

- 3880057 Glacier Pro HD Plow System with Hydraulics: P. 37

Shown on XP Ultimate 2-Seat. Applicable to all models with adjustments. Activity items shown are not sold by Polaris.

WINDSHIELDS

Keep the elements out and control air flow into the cab.



REVOLUTIONARY INSTALLATION

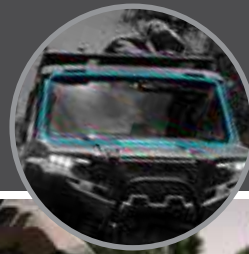

AIRTIGHT GASKET SEAL

GLASS vs POLY

Superior optical clarity (automotive level)
Scratch-resistant
Curved to fit, seals tight
Cold weather / heavy duty
Wiper-ready

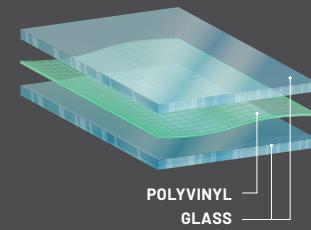

Lightweight, flexible, easy to store/remove
Impact-resistant
Tight seal keeps out rain and dust
Hard Coat: 30x more scratch resistance than regular poly

POLARIS ENGINEERED ADVANTAGES

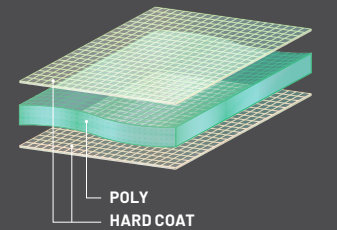

GLASS WINDSHIELD WIPER KIT

» FRONT • 2884484
POLARIS XPEDITION XP/5 '24-25
POLARIS XPEDITION ADV/5 '24-25
ROPS Extension Harness (2885170) required, sold separately

» REAR • 2891036
POLARIS XPEDITION ADV/5 '24-25
Does not include washer system

GLASS

WIPER READY

PRO SHIELD CAB SYSTEMS

TIP OUT WINDSHIELD - GLASS

» 2884408
POLARIS XPEDITION XP/5 '24-25
POLARIS XPEDITION ADV/5 '24-25

WIPER READY

PRO SHIELD CAB SYSTEMS

FULL WINDSHIELD - GLASS

» 2884410
POLARIS XPEDITION XP/5 '24-25
POLARIS XPEDITION ADV/5 '24-25

HARD COAT POLY

PRO SHIELD CAB SYSTEMS

FULL VENTED WINDSHIELD - HARD COAT POLY

» 2884409
POLARIS XPEDITION XP/5 '24-25
POLARIS XPEDITION ADV/5 '24-25

PRO SHIELD CAB SYSTEMS

FULL WINDSHIELD - HARD COAT POLY

» 2884407
POLARIS XPEDITION XP/5 '24-25
POLARIS XPEDITION ADV/5 '24-25

PRO SHIELD CAB SYSTEMS

HALF WINDSHIELD - HARD COAT POLY

» 2884411
POLARIS XPEDITION XP/5 '24-25
POLARIS XPEDITION ADV/5 '24-25

REAR PANELS

Turbulent air forms above the cargo bed and behind the cab when a windshield is added, which can carry dirt, dust, leaves and water into the cab. Control this swirl by adding a rear panel.



PRO SHIELD CAB SYSTEMS

REAR PANEL - GLASS

» 2884412
POLARIS XPEDITION XP/5 '24-25

PRO SHIELD CAB SYSTEMS

REAR LIFTGATE - GLASS

• Two gas struts allow glass to remain in open position for easy gear loading

» 2884413
POLARIS XPEDITION ADV/5 '24-25

PRO SHIELD CAB SYSTEMS

REAR SIDE PANELS - GLASS

» 2889819
POLARIS XPEDITION ADV/5 '24-25

PRO SHIELD CAB SYSTEMS

REAR PANEL - POLY

» 2889344
POLARIS XPEDITION XP/5 '24-25

DOORS

Customize your aesthetic or create an enclosed cab for increased protection from the elements.

POLARIS ENGINEERED ADVANTAGES



PREMIUM INTERIOR HANDLE AND LINER



A PERFECT FIT FOR THE PERFECT SEAL



PRO SHIELD
CAB SYSTEMS
FULL POLY DOORS - MANUAL WINDOWS

- A tight 360° gasket seal to the vehicle keeps the doors fully closed
- Includes a built-in storage compartment with wipe clean inner liner
- Door-mounted crank controls
- Accent panel not included, use with panel from the factory vehicle door

»FRONT • 2884394
POLARIS XPEDITION XP/5 '24-25
POLARIS XPEDITION ADV/5 '24-25

»REAR • 2884395
POLARIS XPEDITION XP/5 '24-25
POLARIS XPEDITION ADV/5 '24-25



PRO SHIELD
CAB SYSTEMS
FULL POLY DOORS - POWER WINDOWS

- A tight 360° gasket seal to the vehicle keeps the doors fully closed
- Includes a built-in storage compartment with wipe clean inner liner
- Console-mounted window controls
- Accent panel not included, use with panel from the factory vehicle door

»FRONT • 2884396
POLARIS XPEDITION XP/5 '24-25
POLARIS XPEDITION ADV/5 '24-25

»REAR • 2884397
POLARIS XPEDITION XP/5 '24-25
POLARIS XPEDITION ADV/5 '24-25



CANVAS UPPER DOORS

- Lightweight, UV-resistant canvas that is stitched over the frame
- Easily mount by attaching directly to the lower stock doors (drill hole plugs included)
- Practical zipper windows with a Velcro® holder increase venting options, without losing visibility

»FRONT • 2884398
POLARIS XPEDITION XP/5 '24-25
POLARIS XPEDITION ADV/5 '24-25

»REAR • 2884406
POLARIS XPEDITION XP/5 '24-25
POLARIS XPEDITION ADV/5 '24-25



SKELETON HALF DOORS

- Round, steel tube frame with formed outer panel
- Provides an open air feel and distinct look, while offering light protection to the cab of the vehicle

»FRONT • 2884717
POLARIS XPEDITION XP/5 '24-25
POLARIS XPEDITION ADV/5 '24-25

»REAR • 2884399
POLARIS XPEDITION XP/5 '24-25
POLARIS XPEDITION ADV/5 '24-25



UNIVERSAL VEHICLE LOCKS

- Includes seven lock tumblers and one set of keys
- Simplify vehicle locks when building a cab with one universal key

» 2889848
POLARIS XPEDITION XP/5 '24-25
POLARIS XPEDITION ADV/5 '24-25

ACCESSORIES

WINDSHIELDS, REAR PANELS & DOORS

CAB COMFORT

VEHICLE PROTECTION

STORAGE

OVERLANDING/ CAMPING & RECOVERY

WINCHES, PLOWS & TRACKS

LIGHTING

CONNECTED TECHNOLOGY

HUNT & COOLERS

WHEELS & TIRES & TRAILERING

CAB COMFORT

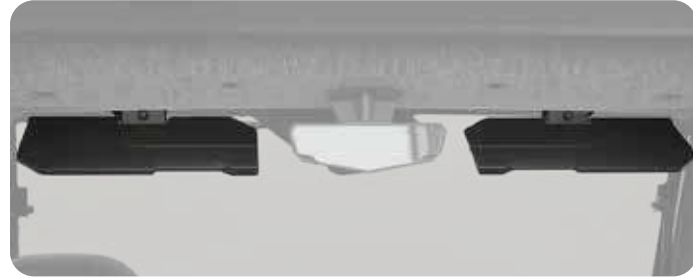

NEW SUN VISORS

- Injection molded and adjustable
- Flip down to protect against sun glare

» 2891239

POLARIS XPEDITION XP/5 '24-25
POLARIS XPEDITION ADV/5 '24-25



NEW GATORSTEP® FULL DOOR DRIVING PADS

- Added cushion at knee and arm touch points for increased comfort

» 2-SEAT • 2891335

POLARIS XPEDITION XP '24-25
POLARIS XPEDITION ADV '24-25



» 5-SEAT • 2891336

POLARIS XPEDITION XP 5 '24-25
POLARIS XPEDITION ADV 5 '24-25



SEE P. 20 FOR WINDSHIELDS

GLASS WINDSHIELD WIPER KIT

» FRONT • 2884484

POLARIS XPEDITION XP/5 '24-25
POLARIS XPEDITION ADV/5 '24-25

ROPS Extension Harness (2885170) required, sold separately

» REAR • 2891036

POLARIS XPEDITION ADV/5 '24-25

Does not include washer system



RAM® PHONE MOUNT

- Easily mounts to the dash and holds a cell phone up to 8.3cm wide

» 2890545

POLARIS XPEDITION XP/5 '24-25
POLARIS XPEDITION ADV/5 '24-25

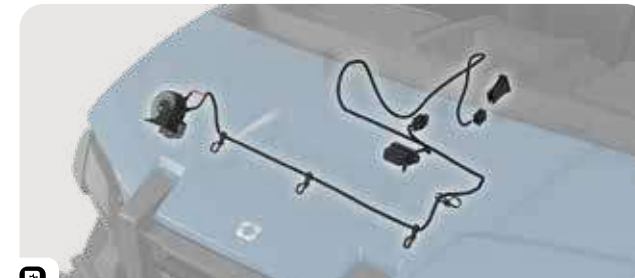

PN HORN KIT

- Adds a warning horn to the vehicle console

» 2884488

POLARIS XPEDITION XP/5 '24-25
POLARIS XPEDITION ADV/5 '24-25



PN LED DOME LIGHT

- Provides optimal visibility in the vehicle cab

» FRONT ROW
2884487

POLARIS XPEDITION XP/5 '24-25
POLARIS XPEDITION ADV/5 '24-25
STANDARD ON NORTHSTAR TRIMS

» REAR ROW / CARGO
2891463

POLARIS XPEDITION XP 5 '24-25
POLARIS XPEDITION ADV 5 '24-25
POLARIS XPEDITION ADV '24-25*
*Cargo only

» CARGO
2890032

POLARIS XPEDITION ADV 5 '24-25
Rear Row Kit (2891463) required, sold separately



ADJUSTABLE FOLDING SIDE MIRRORS

- Fully adjustable for riders of all sizes and can fold in to prevent being struck
- Mounts on any vehicle, with or without doors

» 2884491

POLARIS XPEDITION XP/5 '24-25
POLARIS XPEDITION ADV/5 '24-25



PN HEATER & DEFROST KIT

- Two defrost vents to keep your windows clear and four vents to keep passengers comfortable
- Adjustable temperature control and three fan speeds

» 2889734

POLARIS XPEDITION XP/5 '24-25
POLARIS XPEDITION ADV/5 '24-25



ELECTRICAL INSTALLS MADE EASY WITH
PLUG & PLAY

**POLARIS ENGINEERED
ADVANTAGES**



- To install accessories, simply plug the harness into the Polaris PULSE bar
- No need to remove nuts and stack wire terminals like a three-post terminal setup
- By plugging in your accessories, a secure connection is guaranteed every time

Look for **PN** to identify
Polaris PULSE ready accessories

VEHICLE PROTECTION



BUMPERS

FRONT



HD FRONT BUMPER

- High-strength steel provides additional protection to the front of the vehicle
 - Compatible with the stock 4,500 LB winch, Pro HD High-Mounted 2,722 kg Winch (2884839) and RIGID® Driving LED Lights (2889731), sold separately
- » 2891009-458
POLARIS XPEDITION XP/5 '24-25
POLARIS XPEDITION ADV/5 '24-25

REAR



HD REAR BUMPER

- Durable, powder-coated 4.5cm tube steel
 - Easily attaches to the integrated mounting location
- » 2889331-458
POLARIS XPEDITION XP/5 '24-25
POLARIS XPEDITION ADV/5 '24-25

REAR



REAR BUMPER

- A full-coverage sheet metal face provides additional protection to the rear of the vehicle and the muffler cover
- » 2884498-458
POLARIS XPEDITION XP/5 '24-25
POLARIS XPEDITION ADV/5 '24-25

ROCK SLIDERS

2-SEAT



5-SEAT

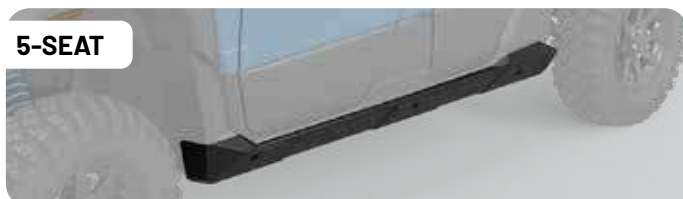

LOW PROFILE ROCK SLIDERS

- Heavy gauge plate steel
 - Seamless integration along vehicle contours
- » 2-SEAT • 2884496-458
POLARIS XPEDITION XP '24-25
POLARIS XPEDITION ADV '24-25

- » 5-SEAT • 2889357-458
POLARIS XPEDITION XP 5 '24-25
POLARIS XPEDITION ADV 5 '24-25

2-SEAT



5-SEAT

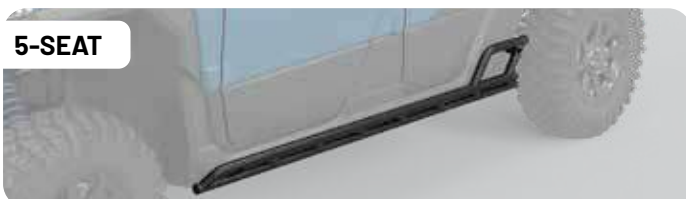

HD EXTREME KICK-OUT ROCK SLIDERS

- 14-gauge, 1.9cm steel tube for superior durability
- » 2-SEAT • 2884495-458
POLARIS XPEDITION XP '24-25
POLARIS XPEDITION ADV '24-25

- » 5-SEAT • 2884497-458
POLARIS XPEDITION XP 5 '24-25
POLARIS XPEDITION ADV 5 '24-25

FENDER FLARES



FULL COVERAGE FENDER FLARES

- Provide additional coverage by helping keep mud and other debris from flying into the cab
 - Installs with the stock fender flares and adds factory styling to your ride
 - Recommend when using the vehicle with snow tracks
- » 2890638
POLARIS XPEDITION XP/5 '24-25
POLARIS XPEDITION ADV/5 '24-25

A-ARM GUARDS

FRONT



REAR



A-ARM GUARDS

- Provides protection to your vehicle without affecting performance
 - A lightweight, poly construction offers strength and durability
 - Simple, secure installation to the steel brackets
- » FRONT • 2884714
POLARIS XPEDITION XP/5 '24-25
POLARIS XPEDITION ADV/5 '24-25

- » REAR • 2884715
POLARIS XPEDITION XP/5 '24-25
POLARIS XPEDITION ADV/5 '24-25

STORAGE

PACK FOR EVERY ADVENTURE

Equip your Polaris XPEDITION with Polaris Engineered storage accessories to pack all your essentials for every outdoor adventure. The versatile lineup includes easy-to-install Lock & Ride MAX accessories — like a bed extender, spare tire carrier and rear storage box — that offer limitless ways to customize your vehicle's storage capabilities.

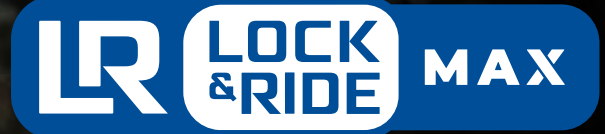

The Lock & Ride MAX system has storage and adaptability built into its DNA. Our next generation of Polaris Lock & Ride technology brings with it an entirely new system of purpose-built accessories and attachments, resulting in an endlessly customizable and remarkably intuitive platform. This means you can go further, push harder and do more than ever before. With virtually limitless configurations and no tools required, you have the freedom to reconfigure on the fly and spend more time doing the things you love.



HOW IT WORKS



1. Choose accessories



2. Position on the vehicle



3. Lock accessories into place



4. Reconfigure as needed

Plus, we've partnered with Rhino-Rack® to deliver premium roof and bed rack solutions. These racks deliver increased storage capacity and allow you to elevate your adventure with item-specific mounts to transport items including kayaks, fishing rods, traction boards and more.



STORAGE



See what storage accessories are compatible with the Lock & Ride MAX rail system and the Rhino-Rack® roof / bed rack system.

PN	PRODUCT	LOCK & RIDE MAX	RHINO-RACK®
2890645	Awning	✓	✓
2889526-458	Kolpin Stronghold Auto-Latch Mount	✓	✓
2890646	MAXTRAX™ Traction Boards & Mounts	✓	✓
2889622	Lock & Ride MAX Bed Rail Kit	✓	
2889621	Lock & Ride MAX Bed Rail Kit	✓	
2889623	Lock & Ride MAX Rear Floor Rail Kit	✓	
2890091-458	Lock & Ride MAX Bed Extender	✓	
2889468-458	Lock & Ride MAX Cross Bed Bar	✓	
2890894	Lock & Ride MAX D-Rings	✓	✓
2889649	Lock & Ride MAX Finish Washer Kit	✓	
2890708	Lock & Ride MAX Rail Cover Kit	✓	✓
2884712	Lock & Ride MAX Rear Storage Box	✓	
2889336-458	Lock & Ride MAX Spare Tire Carrier	✓	
2889884	Rhino-Rack® Accessory Bars		✓
2889531	Rhino-Rack® Cargo Corner Brackets		✓
2889527	Rhino-Rack® Eyelet Tie-Downs	✓	✓
2889729	Rhino-Rack® Fishing Rod Holder		✓
2889337	Rhino-Rack® Gun Mounting Bracket	✓	✓
2889533	Rhino-Rack® High-Lifting Jack Mount		✓
2889883	Rhino-Rack® J-Style Kayak Holder		✓
2889881	Rhino-Rack® 200 L Luggage Bag		✓
2889528	Rhino-Rack® Multi-Purpose Tool Holder	✓	✓
2889590	Rhino-Rack® Rear Bed Rack/Roof Rack, Small		✓
2889237	Rhino-Rack® Roof Rack, Large		✓
2889529	Rhino-Rack® Spare Tire Holder		✓
2889530	Rhino-Rack® Traction Board Mounts		✓



A SPARE TIRE CARRIER

- Holds up to a 30" tire
- Mounts directly to factory bed rails (ADV models only) or the Cross Bed Bar (2889468-458), sold separately

» 2889336-458

POLARIS XPEDITION XP/5 '24-25
POLARIS XPEDITION ADV/5 '24-25
XP models: Cross Bed Bar (2889468-458) required, sold separately

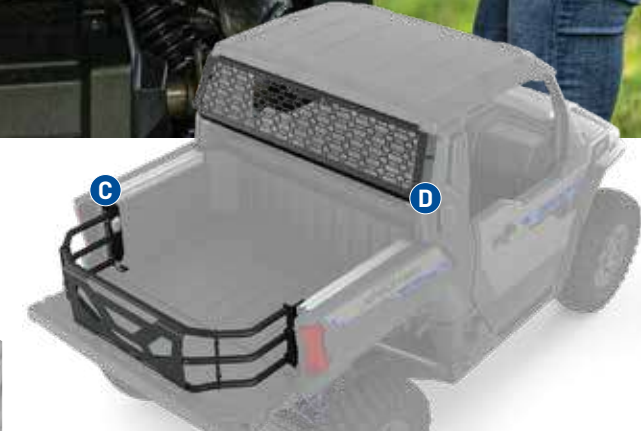

C BED EXTENDER

- Add 30% more cargo space with the rear gate lowered and the extender installed
- Durable, powder-coated tube steel

» 2890091-458

POLARIS XPEDITION XP/5 '24-25
POLARIS XPEDITION ADV/5 '24-25
NOT COMPATIBLE WITH ADV NORTHSTAR

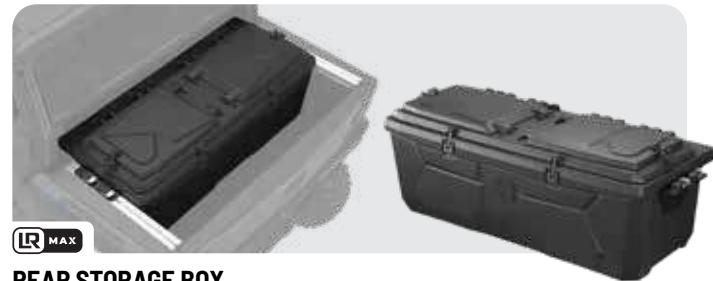

B CROSS BED BAR

- Provides additional mounting options with Lock & Ride MAX accessories
- Can be used as a divider in the vehicle bed
- Quick, toolless install with Lock & Ride MAX slide locks

» 2889468-458

POLARIS XPEDITION XP/5 '24-25
POLARIS XPEDITION ADV/5 '24-25

REAR STORAGE BOX

- Water-resistant design and access door seals to keep gear protected from the elements
- Features one large door and two smaller doors for multiple access options

» 2884712

POLARIS XPEDITION XP/5 '24-25
POLARIS XPEDITION ADV/5 '24-25



HOOD RACK

- Increases load-carrying capacity while also protecting against brush and debris
- 100 LB weight capacity

» STOCK BUMPER • 2889387

POLARIS XPEDITION XP/5 '24-25
POLARIS XPEDITION ADV/5 '24-25

» HD BUMPER • 2884503

POLARIS XPEDITION XP/5 '24-25
POLARIS XPEDITION ADV/5 '24-25



ACCESSORY RAILS

- Additional Lock & Ride MAX rails for expanded storage capacity
- Each kit includes two rails

» BED RAIL KIT 2889622

POLARIS XPEDITION XP/5 '24-25

» BED RAIL KIT 2889621

POLARIS XPEDITION ADV/5 '24-25

» REAR FLOOR RAIL KIT 2889623

POLARIS XPEDITION XP/5 '24-25
POLARIS XPEDITION ADV/5 '24-25



REAR WINDOW MOLLE PANELS

- Attach to the rear side windows of ADV models
- Mount your molle compatible bags or items
- Doubles as a glass protector when used with glass side panels

» 2889478

POLARIS XPEDITION ADV/5 '24-25



RAIL COVER KIT

- Rubber covers to protect your Lock & Ride MAX rails from dirt and debris
- Kit includes eight strips

» 2890708

POLARIS XPEDITION XP/5 '24-25
POLARIS XPEDITION ADV/5 '24-25



KOLPIN STRONGHOLD AUTO-LATCH MOUNT

- Mount a Stronghold Gun Boot (sold separately) and safely transport firearms without taking up cargo bed space

» 2889526-458

POLARIS XPEDITION XP/5 '24-25
POLARIS XPEDITION ADV/5 '24-25
Shown with Kolpin Stronghold Gun Boot XL (2882036), sold separately



FINISH WASHER KIT

- Replaces any Lock & Ride MAX quick attachment to provide semi-permanent mounting and added security
- Kit includes two finish washers

» 2889649

POLARIS XPEDITION XP/5 '24-25
POLARIS XPEDITION ADV/5 '24-25



D-RINGS

- Steel rings securely attach to the Lock & Ride MAX rail system with a wing nut style bolt
- Easily move along the rails to strap down items/loads in the vehicle bed

» 2890894

POLARIS XPEDITION XP/5 '24-25
POLARIS XPEDITION ADV/5 '24-25

See P. 44 for more hunt information

STORAGE | RHINO-RACK®

**BRING IT ALL.
BRING IT ON.***

From opposite sides of the globe, some of the most capable machines in the off-road world meet a trusted outdoor adventure brand to deliver industry-exclusive, purpose-built roof racks, bed racks and attachments that help Polaris XPEDITION riders get the most out of their next adventure.



PICK YOUR RACK



REAR BED RACK / ROOF RACK, SMALL

- Install either in the bed or on the roof of the vehicle (mounts sold separately)
 - A durable backbone provides a secure vehicle attachment
 - An innovative attachment system allows for easy accessory install
 - 34 kg weight capacity per rack
- » 2889590
POLARIS XPEDITION XP/5 '24-25
Small Roof Rack is not compatible with XP 5



ROOF RACK, LARGE

- Install on the roof of the vehicle (mount sold separately)
 - A durable backbone provides a secure vehicle attachment
 - An innovative attachment system allows for easy accessory install
 - 68kg weight capacity
- » 2889237
POLARIS XPEDITION XP 5 '24-25
POLARIS XPEDITION ADV/5 '24-25



ROOF RACK MOUNT

- » **SMALL** • 2889450
POLARIS XPEDITION XP '24-25
- » **LARGE** • 2889451
POLARIS XPEDITION ADV '24-25
- » **LARGE** • 2889452 [NOT SHOWN]
POLARIS XPEDITION XP 5 '24-25
POLARIS XPEDITION ADV 5 '24-25



REAR BED RACK MOUNT

- » 2889453
POLARIS XPEDITION XP/5 '24-25

PICK YOUR MOUNT

ACCESSORIZE IT



SPARE TIRE HOLDER

- Transport a spare tire outside the vehicle
- » 2889529
POLARIS XPEDITION XP/5 '24-25
POLARIS XPEDITION ADV/5 '24-25



200 L LUGGAGE BAG

- Carry bulky, lightweight gear in this tear- and weather-resistant canvas bag
- » 2889881
POLARIS XPEDITION XP/5 '24-25
POLARIS XPEDITION ADV/5 '24-25



GUN MOUNTING BRACKET

- Mount Kolpin Stronghold Gun Boots to Rhino-Rack systems when paired with Auto-Latch Mount (2636942), sold separately
- » 2889327
POLARIS XPEDITION XP/5 '24-25
POLARIS XPEDITION ADV/5 '24-25
[See P. 44 for more hunt information](#)



TRACTION BOARD MOUNTS

- Strong, durable and easy to attach
 - Traction boards sold separately
- » 2889530
POLARIS XPEDITION XP/5 '24-25
POLARIS XPEDITION ADV/5 '24-25



FLAG BRACKET

- Securely mount flags or whips to Rhino-Rack® platform
 - Adjustable bracket with 180-degree folding design
- » 2891228
POLARIS XPEDITION XP/5 '24-25
POLARIS XPEDITION ADV/5 '24-25



HIGH-LIFTING JACK MOUNT

- Simple, quick install with durable brackets
 - Rugged, non-corrosive powder-coated steel stands up to the harshest conditions
- » 2889533
POLARIS XPEDITION XP/5 '24-25
POLARIS XPEDITION ADV/5 '24-25



J-STYLE KAYAK HOLDER

- Transport a kayak or canoe on the roof of your vehicle
- » 2889883
POLARIS XPEDITION XP 5 '24-25
POLARIS XPEDITION ADV/5 '24-25
Accessory Bars (2889884) required, sold separately



EYELET TIE-DOWNS

- Attach in multiple locations on the platform for additional tie-down points
 - Anti-corrosive, galvanized steel for heavy duty strength
 - Includes one set with hardware (straps not included)
- » 2889527
POLARIS XPEDITION XP/5 '24-25
POLARIS XPEDITION ADV/5 '24-25



CARGO CORNER BRACKETS

- Mount a NorthStar cooler or toolbox to the platform and save space inside the vehicle (straps not included)
 - A unique, anti-rotation nut offers maximum security
- » 2889531
POLARIS XPEDITION XP/5 '24-25
POLARIS XPEDITION ADV/5 '24-25



FISHING ROD HOLDER

- Convenient, locking carrier can transport five fishing rods safely and securely on a roof rack
 - Doubles as a ski/snowboard carrier
- » 2889729
POLARIS XPEDITION XP 5 '24-25
POLARIS XPEDITION ADV/5 '24-25

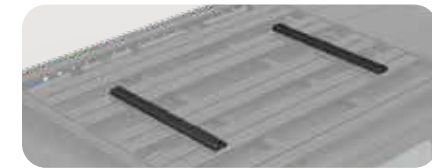

ACCESSORY BARS

- Offers horizontal fitment to allow other accessories to be attached to the Rhino-Rack® platforms
- » 2889884
POLARIS XPEDITION XP 5 '24-25
POLARIS XPEDITION ADV/5 '24-25



MULTI-PURPOSE TOOL HOLDER

- Carry and protect tools, paddles and more
 - Ratchet-locking mechanism for quick release and rubber inserts that secure gear into place
- » 2889528
POLARIS XPEDITION XP/5 '24-25
POLARIS XPEDITION ADV/5 '24-25



ROOF RACK LIGHT MOUNTS

- » **CUBE LIGHT** • 2891355
POLARIS XPEDITION XP/5 '24-25
POLARIS XPEDITION ADV/5 '24-25
- » **LIGHT BAR** • 2891354
POLARIS XPEDITION XP/5 '24-25
POLARIS XPEDITION ADV/5 '24-25
[SEE P. 41 FOR HARNESSSES](#)



*Always read and follow the owner's manual and on-vehicle labels for prohibited items.

OVERLANDING/CAMPING



RECOVERY



ACCESSORIES

WINDSHIELDS, REAR PANELS & DOORS

CAB COMFORT

VEHICLE PROTECTION

STORAGE

OVERLANDING/
CAMPING & RECOVERY

WINCHES, PLOWS
& TRACKS

LIGHTING

CONNECTED TECHNOLOGY

HUNT & COOLERS

WHEELS & TIRES
& TRAILERING



ROOFTOP TENT

- Accommodates up to three people
- Made from a durable, poly/cotton ripstop with a water-resistant coating
- Includes inside pockets, inside rope light, two boot bags and a foam mattress

» 2890560

POLARIS XPEDITION XP 5 '24-25
POLARIS XPEDITION ADV/5 '24-25

Large Roof Rack (2889237) required, sold separately

Make sure vehicle is level, gear selector is in PARK and the wheels are chocked when the tent is deployed.



AWNING

- Provides quick shade when out on the trail
- Lock & Ride MAX technology allows for easy on/off mounting to the vehicle roof or Rhino-Rack® Roof Rack (2889237), sold separately

» 2890645

POLARIS XPEDITION XP 5 '24-25
POLARIS XPEDITION ADV/5 '24-25



HIGH RISE INTAKES

- Optimizes air-induction performance and improves engine abilities in dusty conditions
- Intakes do not increase the water fording line of the vehicle
- Includes left and right intakes

» 2890693

POLARIS XPEDITION XP/5 '24-25
POLARIS XPEDITION ADV/5 '24-25

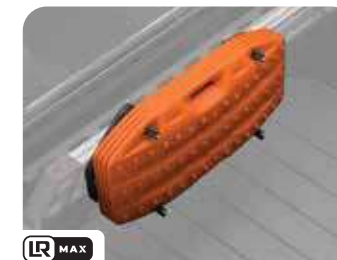

MAXTRAX® TRACTION BOARDS & MOUNTS

- Fiber-reinforced, engineering-grade nylon construction that won't break, crack or stress during use
- All boards are jack-compatible, can be used as a leveling solution and work well with the Rooftop Tent (2890560), sold separately

» 2890646

POLARIS XPEDITION XP/5 '24-25
POLARIS XPEDITION ADV/5 '24-25



RECOVERY SHACKLES

- Provides ideal tie down points for recovery or securing the vehicle on a trailer
- Installs on the stock bumper or accessory HD Front Bumper (2891009-458), sold separately
- Rubber dampeners help provide a quite ride

» 2890542

POLARIS XPEDITION XP/5 '24-25
POLARIS XPEDITION ADV/5 '24-25



91.4cm HIGH-LIFTING JACK

- Assists with trailside repairs or to gain leverage for getting your vehicle unstuck
- Lightweight at under 13.6kg
- Stores easily with a Rhino-Rack® High-Lifting Jack Mount (2889533), sold separately

» 2889508

POLARIS XPEDITION XP/5 '24-25
POLARIS XPEDITION ADV/5 '24-25

See P. 33 for mounting solutions



OFF-ROAD TOOL KIT BY CRUZTOOLS®

» 2890429

POLARIS XPEDITION XP/5 '24-25
POLARIS XPEDITION ADV/5 '24-25

WINCHES, PLOWS & TRACKS



- ✓ TESTED 1,200+ PULLS AT MAX LOAD
- ✓ OPERATES FULLY SUBMERGED
- ✓ BUILT TO WITHSTAND -29° C TEMPERATURES
- ✓ MILITARY TESTED & APPROVED

FEATURES & BENEFITS PRO HD SERIES

- ✓ INTEGRATED WIRING, MOUNT, PREASSEMBLED
- ✓ HOOK WITH STRAP
- ✓ CUT STEEL GEARS & SEALED DRIVETRAIN
- ✓ SEALED PERMANENT MAGNET MOTOR

ALL POLARIS ENGINEERED WINCHES COME WITH:

Retrieve cable 5x as fast as standard mode on other Polaris winches. Get back to riding or complete your task quicker.

1. Set winch dial to N (Neutral) to manually pull the rope out and secure the hook to your anchor point
2. Set winch dial to L (Low) for maximum pulling power while winching your load
3. Set winch dial to H (High) for retrieving the rope 5x faster with Rapid Rope Recovery

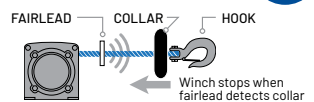

Auto Stop technology protects and extends the life of your winch by automatically stopping the winch at the end of pull to prevent over-spooling. While plowing, it prevents the plow frame from bending by stopping the winch once the plow has been lifted.



With its lightweight, yet extremely strong, design and superior flexibility, this 15 m long synthetic rope is easy to handle and can stand up to any tough job.



This convenient remote operates your Polaris winch wirelessly from within 15 m of the vehicle. Operate your winch safely outside your vehicle while on the job site or trails.

MODEL	HIGH-MOUNTED 2,722 kg	2,041 kg
POLARIS XPEDITION XP/5 '24-25	2884839	2884838
POLARIS XPEDITION ADV/5 '24-25	Requires HD Front Bumper (2891009-458), sold separately	

UPGRADES & REPLACEMENTS

15 M SYNTHETIC ROPE

- » 2879188 2,041 KG SERIES
- » 2879187 2,041 KG SERIES

WIRELESS REMOTE

- Up to 15 m range with LED indicator
- Direct plug & play operation
- » 2889561

AUTO STOP UPGRADE

- Billet aluminum
- Replaces stock fairlead
- » 2890454

Synthetic Rope & Wireless Remote (2889561) required, sold separately

PLOW SYSTEMS

Choose a Glacier Plow System, designed to help you get the most out of your Polaris XPEDITION during snowy months. Select a system based on your plowing needs with premium add-ons including a hydraulic lift system or additional plow accessories. Additionally, plow mode is enabled in all vehicles equipped with the 7" Display powered by RIDE COMMAND, which automatically raises and lowers the plow when shifting between gears.

GLACIER PRO HD PLOW SYSTEM WITH HYDRAULICS

- System includes:
- Mount (2889578)
 - Frame (2889579)
 - Hydraulic Angle System (2889029)
 - Plow Control Handle (2889721)
 - 183 cm Steel Blade (2879874)
 - Plow Markers (2890649)
 - 15cm Blade Extensions (2889328)

» 3880057
POLARIS XPEDITION XP/5 '24-25
POLARIS XPEDITION ADV/5 '24-25

GLACIER PRO HD PLOW SYSTEM

- System includes:
- Mount (2889578)
 - Frame (2889579)
 - 168 cm Poly Blade (2879317)
 - Plow Markers (2890649)

» 3880058
POLARIS XPEDITION XP/5 '24-25
POLARIS XPEDITION ADV/5 '24-25

GLACIER HD PLOW SYSTEM

- System includes:
- Mount (2889578)
 - Frame (2889580)
 - 168 cm Steel Blade (2880270)

» 3880059
POLARIS XPEDITION XP/5 '24-25
POLARIS XPEDITION ADV/5 '24-25



51 cm

183 CM STEEL BLADE
BEST FOR BIG JOBS YEAR AFTER YEAR

183 CM POLY BLADE
BEST FOR CORROSION RESISTANCE

BUILD YOUR PLOW SYSTEM	STEP 1 SELECT A MOUNT	STEP 2 SELECT A FRAME	STEP 3 SELECT A LIFT METHOD	STEP 4 SELECT A BLADE	STEP 5 SELECT ACCESSORIES
POLARIS XPEDITION XP/5 '24-25 POLARIS XPEDITION ADV/5 '24-25	2889578	Pro HD Push Frame 2889579 TO INSTALL TRACKS: Track Extension 2890650 Plow Extension 2879871	Stock Winch from Factory Polaris Pro HD 2,041 kg Winch 2884838 Polaris Pro HD 2,722 kg Winch 2884839 Hydraulic Angle System* 2889029 Plow Control Handle 2889721	183 cm Steel Blade 2879874 183 cm Poly Blade 2879317	183 cm Blade Snow Deflector 2858541 183 cm HD Wear Bar 2879875 183 cm Replacement Wear Bar 2204976 Heavy Duty Deflector 2884160 15 cm Blade Extensions* 2889328 Plow Markers 2890649 <small>*Not compatible with tracks</small>



51 cm

183 CM STEEL BLADE

BUILD YOUR PLOW SYSTEM	STEP 1 SELECT A MOUNT	STEP 2 SELECT A FRAME	STEP 3 SELECT A LIFT METHOD	STEP 4 SELECT A BLADE	STEP 5 SELECT ACCESSORIES
POLARIS XPEDITION XP/5 '24-25 POLARIS XPEDITION ADV/5 '24-25	2889578	HD Push Frame 2889580 <small>Not compatible with tracks</small>	Stock Winch from Factory Polaris HD 2,041 kg Winch 2884838 Polaris Pro HD 2,722 kg Winch 2884839	183 cm Steel Blade 2880270	183 cm Blade Snow Deflector 2858541 183 cm HD Wear Bar 2879875 Replacement Shear Pin 2205527 Heavy Duty Deflector 2884160 Plow Markers 2890649

POLARIS PLOW MODE ENABLED IN ALL VEHICLES WITH RIDE COMMAND

Plow automatically lowers when shifting into low | Plow automatically raises when shifted into reverse | Back drag mode for pulling snow away from buildings



PROSPECTOR PRO 2.0 TRACK SYSTEM

- Minimize track slip to provide better climbing ability and improved traction in deep snow
- Installs in place of tires and recommended for optimal traction in snowy conditions

» TRACKS • 2890016
POLARIS XPEDITION XP/5 '24-25
POLARIS XPEDITION ADV/5 '24-25

» MOUNTS + HIGH RISE INTAKES • 2890014
POLARIS XPEDITION XP/5 '24-25
POLARIS XPEDITION ADV/5 '24-25

CHOOSE A PLOW SYSTEM

BUILD A PLOW SYSTEM

ACCESSORIES

WINDSHIELDS, REAR PANELS & DOORS

CAB COMFORT

VEHICLE PROTECTION

STORAGE

OVERLANDING/ CAMPING & RECOVERY

WINCHES, PLOWS & TRACKS

LIGHTING

CONNECTED TECHNOLOGY

HUNT & COOLERS

WHEELS & TIRES & TRAILERING

LIGHTING



FROM DUSK 'TIL DAWN

Extend your ride time and be more visible to others with the brightest light bars in the industry.

RIGID

127cm CURVED RDS SR-SERIES LIGHT BAR

A trusted name in the off-road lighting industry, RIGID delivers unmatched technology and superior performance.

RIGID
D-SERIES POD
LIGHTS & MOUNTS

RIGID
SR-M-SERIES PRO
DRIVING LED LIGHTS

2889731

RIGID
SCENE LIGHTS

2884783

PRO ARMOR
83.3cm SINGLE-ROW LIGHT BAR

Pro Armor gives you aggressive styling, rugged protection and lighting solutions for your riding needs.

ACCESSORIES

WINDSHIELDS, REAR
PANELS & DOORS

CAB COMFORT

VEHICLE
PROTECTION

STORAGE

OVERLANDING/
CAMPING & RECOVERY

WINCHES, PLOWS
& TRACKS

LIGHTING

CONNECTED
TECHNOLOGY

HUNT & COOLERS

WHEELS & TIRES
& TRAILERING

39



POLARIS ENGINEERED ADVANTAGES

MOUNTS PERFECTLY
Designed for your Polaris Engineered bumper, roof or other mounting point

MAX PERFORMANCE
Validated to work as hard as your machine does

DOESN'T OVERTAX
Trust it to work when you need it to

PRO ARMOR



ADVANCED TECH

RIGID® lights are driven by Aluminum PCB Smart Boards®, 6063-T5 aircraft aluminum extruded housings and Tiger Drylac® UV protection polyester powdercoating.

EXCLUSIVE OPTICS

RIGID® invests heavily in optical science and has patented multiple optics and optics systems, maximizing light output and efficiency.

RUGGED CONSTRUCTION

Pro Armor lights are designed to be big and beefy with an aggressive style all their own, and housed in IP67 marine-grade rated UV polyester powdercoating.

MASSIVELY BRIGHT

Pro Armor builds bright lights designed for any riding experience. All that power is directed through heat dissipating aluminum for streamlined heat management.



LIGHT BAR TYPES



SR-SERIES PRO

Sleek, powerful, low-profile (under 5 cm tall). Lights extreme distances with low energy usage.
Available in Driving, 25.4 cm, 81.3 cm & 101.6 cm



D-SERIES PRO

Compact to fit almost anywhere with high output and low energy usage.
Available in Driving, Flood & Spot



DUAL-ROW LED

The most spread and farthest illumination downrange. Easy to mount.
Available in Cube, 27.9 cm & 78.7 cm



SINGLE-ROW LED

Powerful, compact, low-profile light bars with sleek look.
Available in 27.9 cm, 50.8 cm, 83.8 cm & 101.6 cm



CUBE LED

Small size allows mounting in strategic locations for added lighting.
Available in Spot

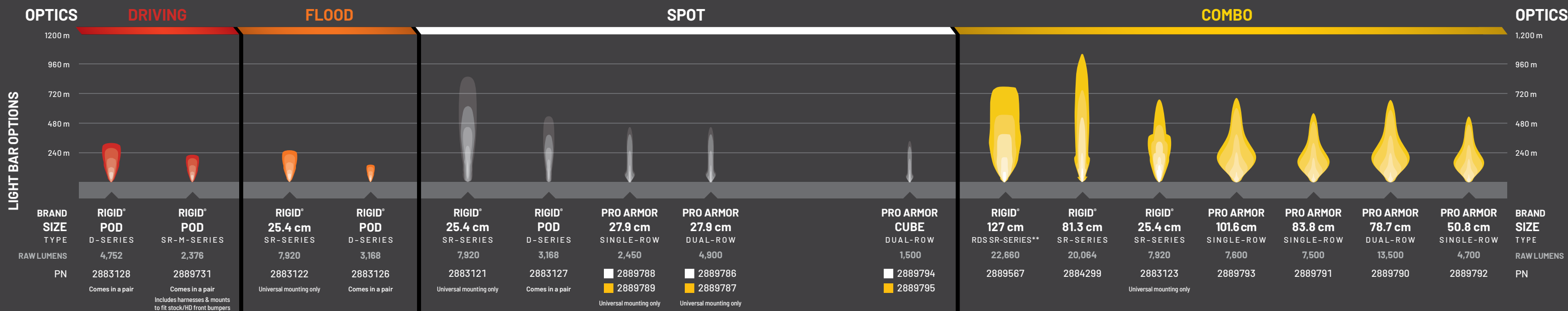

BUILD YOUR VISION

Consider the optics, angle & how you will use your vehicle to choose the right light or set of lights.

OPTICS LIGHT ANGLE	ACCENT	DRIVING (45°)	FLOOD (25°)	SPOT (10°)	COMBO (25°/10°)
DRIVING SPEED	All	Slow to medium	Slow to medium	High	All
BEAM	Diffused glow	Extra-wide	Wide/shorter	Concentrated/long	Inner spot & outer flood
RECOMMENDED MOUNTING	Low/wheel well	All points	Low/rear	High points	All points
TERRAIN & RIDING STYLE	Added style & personalization in any terrain	All riding & utility	Wide-open terrain or trails & utility	Trail & tight conditions	All riding & utility

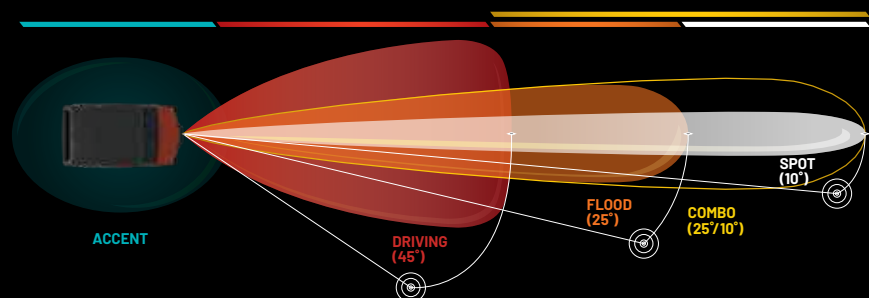

ADD MOUNTS & HARNESSES TO INSTALL YOUR LIGHTS

TYPE OF LIGHT	LIGHT LOCATION: BUMPER	LIGHT LOCATION: FRONT ROOF	LIGHT LOCATION: REAR ROOF	LIGHT LOCATION: RHINO-RACK® ROOF RACK
POD/CUBE LIGHTS	FRONT HD BUMPER CUBE LIGHT MOUNTS 2889820 FRONT HD BUMPER CUBE LIGHT HARNESS + SWITCH** 2889885	FRONT ROOF CUBE LIGHT MOUNTS 2889849 FRONT ROOF CUBE LIGHT HARNESS + SWITCH 2889891	REAR ROOF CUBE LIGHT HARNESS + SWITCH 2889730 <small>Universal mounting with lights</small>	NEW CUBE LIGHT MOUNT 2891355 FRONT ROOF CUBE LIGHT HARNESS + SWITCH 2889891 REAR ROOF CUBE LIGHT HARNESS + SWITCH 2889730
50.8CM-101.6CM LIGHT BARS	N/A	FRONT ROOF LIGHT BAR MOUNTS 2889643 FRONT ROOF LIGHT BAR HARNESS 2889892	REAR ROOF LIGHT BAR HARNESS 2889853 <small>Universal mounting with lights</small>	NEW LIGHT BAR MOUNT 2891354 FRONT ROOF LIGHT BAR HARNESS 2889892
127cm LIGHT BAR**	N/A	127cm LIGHT BAR HARNESS** 2889591 <small>Mounts included with light bar</small>	N/A	N/A



RIGID® SCENE LIGHTS

- Provides a "soft" aerial light to increase visibility around the camp or jobsite
 - Includes two side-mounted lights, one rear-mounted light and system wiring harness
- » 2884783
POLARIS XPEDITION XP/5 '24-25
POLARIS XPEDITION ADV/5 '24-25



**Check with your local dealer for availability.

⚠ No battery connection cables required on any Polaris XPEDITION.

🔌 All RIGID® and Pro Armor lights are Polaris PULSE ready.

[POLARIS.COM/ShopPolarisXPEDITION](https://Polaris.com/ShopPolarisXPEDITION)

ACCESSORIES

WINDSHIELDS, REAR PANELS & DOORS

CAB COMFORT

VEHICLE PROTECTION

STORAGE

OVERLANDING/ CAMPING & RECOVERY

WINCHES, PLOWES & TRACKS

LIGHTING

CONNECTED TECHNOLOGY

HUNT & COOLERS

WHEELS & TIRES & TRAILERING

CONNECTED TECHNOLOGY

GO REMOTE.
STAY CONNECTED.



POLARIS RIDECOMMAND

PLAN YOUR RIDE

Plan an epic ride with stops along the way, customize and adjust your path to maximize your route or follow turn-by-turn directions. You can even share your planned route with friends.

FOLLOW THE GROUP

With Group Ride, you can ride at your own speed and keep fellow riders in sight on your map screen, even if you get split up. Because rides are meant to be shared.

WORK SMARTER

Plow Mode automatically raises and lowers the plow depending on the gear you're in, so that you can get your work done quicker.

DISCOVER NEW TRAILS

With over 1,000,000 miles of trails available offline, you'll have the confidence to explore further, whether you have cellular coverage or not.

7" DISPLAY POWERED BY RIDE COMMAND

Bright, glove-compatible touchscreen visible in all conditions.

Camera Integration

Navigate with full view of your surroundings. Use the integrated rear camera to see others behind you while riding.

Personalized Audio Experience

Seamlessly pair to your display via Bluetooth* to wirelessly stream music and stay connected with call and text alerts.

Configurable Gauges

Customize your ride experience with elevation, travel direction, fuel level and more to create relevant screens for you.

»2884072

POLARIS XPEDITION XP/5 '24-25
POLARIS XPEDITION ADV/5 '24-25

HUNT



KOLPIN
OUTDOORS

**PROTECTING YOUR
ESSENTIAL GEAR SINCE 1943**



ACCESSORIES

WINDSHIELDS, REAR
PANELS & DOORS

CAB COMFORT

VEHICLE
PROTECTION

STORAGE

OVERLANDING/
CAMPING & RECOVERY

WINCHES, PLOWS
& TRACKS

LIGHTING

CONNECTED
TECHNOLOGY

HUNT/COOLERS

WHEELS & TIRES
& TRAILERING

KOLPIN STRONGHOLD CASES & MOUNT



KOLPIN STRONGHOLD GUN BOOT XL

- Includes zippered internal liner
- Lockable

» 2882036

POLARIS XPEDITION XP/5 '24-25
POLARIS XPEDITION ADV/5 '24-25
Auto-Latch Mount (2889526-458 or
2636942) required, sold separately



KOLPIN STRONGHOLD GUN BOOT L

» 2882426

POLARIS XPEDITION XP/5 '24-25
POLARIS XPEDITION ADV/5 '24-25
Auto-Latch Mount (2889526-458 or
2636942) required, sold separately



LR MAX KOLPIN STRONGHOLD AUTO-LATCH MOUNT

» 2889526-458

POLARIS XPEDITION XP/5 '24-25
POLARIS XPEDITION ADV/5 '24-25

AUTO-LATCH MOUNT

» 2636942

POLARIS XPEDITION XP/5 '24-25
POLARIS XPEDITION ADV/5 '24-25

RHINO-RACK® MOUNT



RHINO-RACK® GUN MOUNTING BRACKET

- Mount Kolpin Stronghold Gun Boots to Rhino-Rack® systems when paired with Auto-Latch Mount (2636942), sold separately

» 2889327

POLARIS XPEDITION XP/5 '24-25
POLARIS XPEDITION ADV/5 '24-25

See P. 32 for more Rhino-Rack® products

KOLPIN RHINO GRIPS IDEAL FOR BOWS & UNCASSED GUNS



LR MAX RHINO GRIP PRO

» 2884107
POLARIS XPEDITION XP/5 '24-25
POLARIS XPEDITION ADV/5 '24-25



LR MAX RHINO GRIP XLR

» 2881574
POLARIS XPEDITION XP/5 '24-25
POLARIS XPEDITION ADV/5 '24-25



LR MAX RATCHETING RHINO GRIP

» 2881575
POLARIS XPEDITION XP/5 '24-25
POLARIS XPEDITION ADV/5 '24-25



LR MAX RHINO GRIP XLR - DOUBLES

» 2889166
POLARIS XPEDITION XP/5 '24-25
POLARIS XPEDITION ADV/5 '24-25

Never transport a loaded firearm. Verify firearm is unloaded prior to mounting. Please refer to local laws and regulations regarding the requirements for the legal transport of firearms.

All Kolpin Rhino Grips are Lock & Ride MAX / Lock & Ride compatible and come with required mounting hardware.

COOLERS

MADE FOR RIDERS.
BUILT FOR LIFE.



28, 57 & 99
LITER FEATURES



ComfortCarry
Handles



TravelLock
System



EasyOut
Drain System



NoSlip
Rubber Feet



PolarWall
Insulation



IceLock
Seal

POLARIS NORTHSTAR COOLERS CAN SURVIVE JUST ABOUT ANYTHING - FROM EXTREME HEAT TO A NASTY TUMBLE OFF A VEHICLE.



99 LITER

SAGEBRUSH GREEN • 2890707
GRAPHITE • 2883426

ACCESSORIES

WIRE BASKET • 2883648
DIVIDER (1) • 2883468
WHEELS • 2883967

Divider

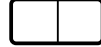

1 way to
partition



57 LITER

SAGEBRUSH GREEN • 2890706
GRAPHITE • 2883425

ACCESSORIES

WIRE BASKET • 2882185
DIVIDERS (2) • 2882184
SEAT CUSHION • 2882179
WHEELS • 2882180

Dividers



2 ways to
partition



28 LITER

SAGEBRUSH GREEN • 2890705
GRAPHITE • 2883424

ACCESSORIES

WIRE BASKET • 2882438
DIVIDER (1) • 2882186

Divider



1 way to
partition



14 LITER

SAGEBRUSH GREEN • 2890704
GRAPHITE • 2883968



19 LITER
SOFT-SIDED COOLER

GRAPHITE • 2889285



HOLDS ICE FOR AGES

BECAUSE JUST ANY COOLER WON'T CUT IT OUT THERE.

You need something rugged and reliable. A cooler purpose-built to handle the challenges of the off road—while keeping your provisions on ice for days on end. Because out here, there are no ice machines, and you just left the last one in your dust. So, load it up. Lock it in. And know your NorthStar cooler is staying put—giving you a few extra days of ice time to enjoy the wild.

ESSENTIAL ACCESSORIES SO YOUR COOLER WORKS AS HARD AS YOU DO

WIRE BASKET



DIVIDERS Doubles as cutting board



SEAT CUSHION



WHEELS



TUMBLER



591 mL • 2883393

ACCESSORIES

WINDSHIELDS, REAR
PANELS & DOORS

CAB COMFORT

VEHICLE
PROTECTION

STORAGE

OVERLANDING/
CAMPING & RECOVERY

WINCHES, PLOWS
& TRACKS

LIGHTING

CONNECTED
TECHNOLOGY

HUNT & COOLERS

WHEELS & TIRES
& TRAILERING

WHEELS & TIRES

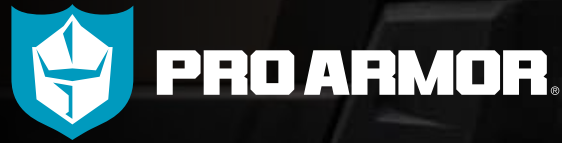

OFF-ROAD, IT'S ALL ABOUT FREEDOM & CREATING YOUR OWN PATH

As serious riders ourselves, we get it. And everything we design is to get (and keep) you going on the ride of a lifetime. We're for every style of rider looking to go beyond the expected with a ride that will make your story epic.



WHY CHOOSE PRO ARMOR? SUPERIOR PERFORMANCE & DURABILITY

LIFELONG PERFORMANCE

- Every tire is designed and constructed with **longevity** in mind
- **3,000+ mile rated** (4,828 kilometers)

PREMIUM PROTECTION

- Pro Armor makes tires with **extra protection** exactly where it's needed most – the sidewall
- **Triple-belted sidewalls** keep your tires more resistant so you can keep going. Many competitors only use double-belted sidewalls

TOUGH TIRES

- Higher ply ratings mean added protection
- Pro Armor builds 8 or 10-ply rated tires for **higher puncture-resistance**



TIRES

Developed and tested with Polaris engineers, ensuring the perfect fit and optimal performance mile after mile.



15" WHEEL

SINGLE-DUROMETER

PRO ARMOR CRAWLER XR

Premium grip for most terrains, from desert trails to the rocks.

Why Choose Crawler XR?
Tougher durometer allows for a shorter lug without sacrificing tread life and saves weight. Excels in hard-pack, fast terrain.



15" WHEEL

DUAL-DUROMETER

PRO ARMOR CRAWLER XG

Unmatched grip for rock crawling with a taller, softer lug.

Why Choose Crawler XG?
Perfect balance between high-speed performance, durability and flex for traction on slick rocks.



15" WHEEL

DUAL-DUROMETER

PRO ARMOR CRAWLER AT

Handle anything the trail has to throw at you. In the sand or a rocky trail, these tires will stand up to almost anything.

Why Choose Crawler AT?
Directional lug pattern, more grip and better traction and wider lug spacing for excellent mud clean-out.



15" WHEEL

DUAL-DUROMETER

PRO ARMOR CRAWLER XP

The best in performance, durability, and reliability. Designed to tackle the toughest terrain in the most challenging conditions.

Why Choose Crawler XP?
Superior handling in soft dirt and clay. Extended side lugs for greater traction on rocks and sand.



15" WHEEL

DUAL-COMPOUND

PRO ARMOR MUD XC

The best tread design that balances aggressive traction in the mud with a smoother ride on the trail.

Why Choose Mud XC?
Perfect mud-trail crossover.



15" WHEEL

DUAL-DUROMETER

PRO ARMOR ATTACK 2.0

All purpose tread pattern with a 10-ply radial construction provides excellent traction and increased durability.

Why Choose Attack 2.0?
Tighter lug spacing provides better traction in hard-pack & 10-ply construction provides long-lasting durability.



15" WHEEL

PRO ARMOR HARVESTER

Designed for trail & agricultural applications with excellent grip, minimal crop impact and long wear life.

Why Choose Harvester?
Great for unexpected impact and rugged terrain.



15" WHEEL

PRO ARMOR PRO RUNNER

Lightweight high-performance tire with aggressive lug design for incredible grip.

Why Choose Pro Runner?
Lightweight construction without sacrificing durability.



15" WHEEL

PRO ARMOR TREKKER

The best balance of on-trail handling and low tire noise.

Why Choose Trekker?
Ultimate predictability with a quiet ride.

KNOW YOUR TERRAIN



- Tread patterns optimized for extreme traction
- Ideal for both hard pack & loose trail



- Provides traction & durability
- Performs in hard sand, jagged rocks or any extreme terrain



- Flexible "grippy" tread
- Aggressive side bite



- Extra deep treads
- Self-cleaning lugs



- Triple-belted sidewalls to resist puncture
- Purpose-built, long lasting tread patterns



- Handles extreme cold
- Holds shape & provides traction



PRO ARMOR TIRES HAVE BEEN DEVELOPED AND TESTED to ensure the perfect fit, superior durability and optimal performance, mile-after-mile. No matter where you ride - mud, dirt, sand or snow - we've got you covered.

WHEELS

KNOW YOUR TERRAIN



- Tread patterns optimized for extreme traction
- Ideal for both hard pack and loose trail



- Extra deep treads
- Self-cleaning lugs



- Triple-belted sidewalls to resist puncture
- Purpose-built, long lasting tread patterns



- Flexible "grippy" tread
- Aggressive side bite



A BEADLOCK INCLUDED

B BEADLOCK INCLUDED

E BEADLOCK INCLUDED

15"

50-SERIES

A 5302 BEADLOCK 5

WEIGHT: 6.1 kg	LOAD RATING: 590 kg	OFFSET: +55
MATTE BLACK: FRONT/REAR	15" x 7"	1524038

B 5304 BEADLOCK 5

WEIGHT: 7.3 kg	LOAD RATING: 726 kg	OFFSET: +62
MATTE BLACK: FRONT/REAR	15" x 7"	1525420

C 5306 5

WEIGHT: 6.8 kg	LOAD RATING: 789 kg	OFFSET: +62
MATTE BLACK: FRONT/REAR	15" x 7"	1525684

D 5307 5

WEIGHT: 7.3 kg	LOAD RATING: 789 kg	OFFSET: +62
MATTE BLACK: FRONT/REAR	15" x 7"	1525686

E 5307 BEADLOCK 5

WEIGHT: 8.2 kg	LOAD RATING: 789 kg	OFFSET: +62
MATTE BLACK: FRONT/REAR	15" x 7"	1525688

5 WHEELS WITH 5 LUG NUTS

KNOW YOUR WHEELS

EX: 5302 BEADLOCK

STEP 1:
SELECT YOUR SERIES

5 = 50-SERIES

STEP 2:
CHOOSE YOUR LOAD RATING

- 1 = <362.9 KG
- 2 = 363 - 589.7 KG
- 3 = 590 - 726+ KG

STEP 3:
PICK YOUR STYLE

OFFSET / BEADLOCK / COLOR
 INCREASE OFFSET FROM STOCK = NARROWER STANCE
 DECREASE OFFSET FROM STOCK = WIDER STANCE

WHEEL & TIRE SETS

15"

50-SERIES

	BACKCOUNTRY/TRAIL		MUD	UTILITY	DESERT/ROCK				
	ATTACK 2.0 30"	TREKKER 30"	MUD XC 30"	HARVESTER 30"	CRAWLER XR 30"	CRAWLER XP 30"	CRAWLER XG 30"	CRAWLER AT 30"	PRO RUNNER 30"
5302 BEADLOCK MATTE BLACK	2889934	2890921	2890841	2889936	2890846	2889946	2889935	2889937	2890844
5304 BEADLOCK MATTE BLACK	2889994	2891006	2890674	2889996	2890673	2890672	2889995	2889999	2890843
5306 MATTE BLACK	2890932	2890917	2890948	2890949	2890943	2890946	2890938	2890941	2890935
5307 MATTE BLACK	2890951	2890918	2890967	2890968	2890962	2890965	2890957	2890960	2890954
5307 BEADLOCK MATTE BLACK	2890970	2890919	2890986	2890987	2890981	2890984	2890976	2890979	2890973

2 WAYS TO PURCHASE

INDIVIDUAL WHEELS & TIRES
 - OR -
 COMPLETE SETS AS LISTED

Exclusively at Polaris Authorized Dealers



PREMIUM TIRE SEALANT

- » 946 mL • 2830484
 - » 3.8 LITERS • 2830485
 - » 19 LITERS • 2830486
 - » 19 LITERS PUMP • 2830487
- See P. 54 for more information

TIRE SEALANT

24 x 7 COVERAGE | BE PREPARED FOR ANYTHING

HOW IT WORKS

- 1 Tire sealant remains liquefied inside the tire until a leak develops in the tire or wheel.
- 2 Once a leak occurs, the tire sealant rushes out of the tire and quickly creates a permanent solid plug, maintaining tire pressure so you can continue your ride.



HOW MUCH DO YOU NEED?

$$\text{TIRE HEIGHT (IN.)} \times \text{TIRE WIDTH (IN.)} / 5 = \text{LITERS REQUIRED PER TIRE}$$

PREMIUM TIRE SEALANT

- Instantly seals and repairs rim, bead leaks and punctures up to 0.64 cm on standard tires and 1.9 cm on heavy ply tires
- Helps seal the tire bead against the wheel
- Creates permanent repair, helps maintain air pressure for the life of the tire
- 100% water soluble for easy cleanup
- Remains fluid and effective in temperatures down to -43° C
- Will not rust, corrode or pit wheels
- Easily installed through existing tire valve stem with valve core removed

- » 946 mL • 2830484
- » 3.8 L • 2830485
- » 19 L • 2830486
- » 19 L PUMP • 2830487
- » 208 L • 2830489
- » 1041 L • 2830488

CV BOOT REPAIR KIT*

FIX ON THE GO | TEMPORARY COVERAGE

- A quick trail-side fix to increase trail time
- The flexible and durable boot material expands over a cone tool for CV boot repairs, without disassembling CV axles
- Universal fit – works as a temporary fix for most powersports axles
- All components fit inside the cone, and a cover is provided for compact durable storage
- Easily fits in a cargo box, attached to the roll cage, in the glovebox or many other storage locations



Items shown are contained inside cone

UTV CV BOOT REPAIR KIT

Kit includes the following items:

- (1) Expandable XL CV Boot
 - (1) Reusable Cone Tool
 - (2) CV Boot Clamps
 - (1) Tube of Silicone Lube
 - (1) Grease Packet
 - (1) Cone Cover
- » 2830526

UTV TRAIL BOOT ONLY

» 2830527

ATV

- » CV REPAIR KIT 2830528
- » TRAIL BOOT ONLY 2830529

HOW TO INSTALL

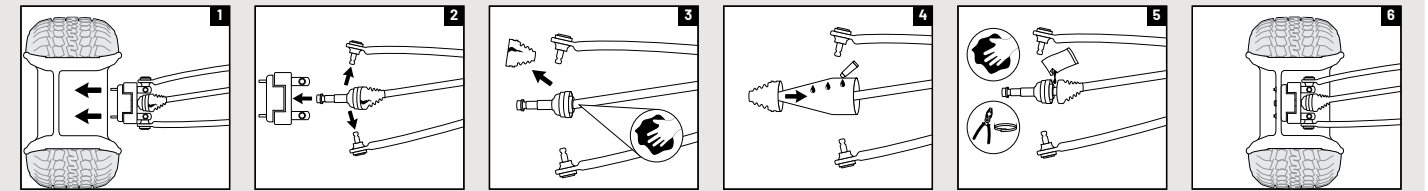

- 1 Remove wheel and axle nut.
- 2 Remove brake caliper, hub, tie rod and upper and lower ball joints.
- 3 Remove old boot and clean joint.
- 4 Spread silicone lube on entire cone tool. Slide boot over cone tool, large end first. See package for outer boot instructions.
- 5 Empty the bag of grease into the CV joint/boot, clean sealing points and install clamps.
- 6 Reassemble tie rod, ball joints, brake caliper, axle nut, tire and wheel.

Refer to your service manual for further instructions and torque specifications.
*Designed for temporary CV boot repair. Purchase the OEM CV Boot for a permanent repair.

TRAILERING

RAMPS



CALIBER® RAMP PRO

- Designed for ATVs and UTVs up to 127 cm wide
 - Integrated grip glides for ultimate traction
 - Folding sides for easy transportation and storing
- » 132 cm x 229 cm • 2884576



ALUMINUM ARCHED LOADING RAMPS

- Capacity for up to 1,361 kg, 680.7 kg per ramp
- » 193 cm x 30.5 cm • 907 kg • 2875384
» 224 cm x 30.5 cm • 1,361 kg • 2875386

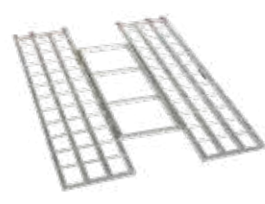

LIGHTWEIGHT TRI-FOLD RAMPS

- Ramp folds up for transport
 - Capacity for up to 680.7 kg
 - Safety straps included
- » 183 cm x 130 cm • 2875385
» 208 cm x 130 cm • 2875860



FOLDING ALUMINUM ARCHED RAMPS

- Ramp folds up for transport
 - Up to total capacity, 340 kg per individual ramp
 - Safety straps included
- » 224 cm x 30.5 cm • 2875387

COVERS

TRAILERABLE COVER

- » 2-SEAT • 2889723
POLARIS XPEDITION XP '24-25
- » 5-SEAT • 2889724
POLARIS XPEDITION XP '24-25
- » 2-SEAT • 2889725
POLARIS XPEDITION ADV '24-25
- » 5-SEAT • 2889726
POLARIS XPEDITION ADV '24-25



HITCHES



HITCH WITH 5 cm BALL

- 3:1 Hitch: ball, hook and pin design
 - Rust resistant steel with powdercoat finish
 - Removable ball, HD 1.6 cm pin and clip
- » 5 cm x 5 cm RECEIVER • 2830522
» 3 cm x 3 cm RECEIVER • 2830523



4.8 cm BALL

- eplacement ball for hitch
 - Works with 3:1 Hitch
- » 2830524



RECEIVER HITCH

- » 5 cm RECEIVER TONGUE 2875320



TRAILER BALL 1.9 cm SHANK

- » 4.8 cm BALL • 2877602
- » 5 cm BALL • 2877603

STRAPS & ROPES



RECOVERY STRAP

- 5 cm x 9.1 m
 - 8,165 kg maximum load, 4,082 kg maximum vehicle weight
 - Comes with carry bag
- » 2884033



RATCHET STRAP

- 3.8 cm x 4.6 m straps, 2 pack
 - Heavy duty webbing
 - 2,495 kg maximum load, 831 kg working load
- » 2884031



RATCHET STRAP

- 5 cm x 6.1 m
 - Heavy duty webbing, floating D-rings, double J-hooks
 - 4,536 kg maximum load, 1,497 kg working load
- » 2884032



SHOCK STRAPS

- 3.8 cm, 1,361 kg breaking strength
 - Keeps tension on tie-down straps to secure load, 2 pack
- » 3.8 cm x 4.6 m • 2883296
» 3.8 cm x 2.1 m • 2883295



MAINTENANCE & GARAGE

FACTORY APPROVED. Every Polaris vehicle has been engineered and manufactured to deliver performance. Keep it that way by using the same lubricants, cleaners and service parts our factory-trained technicians use.

MAINTENANCE PARTS & FLUIDS

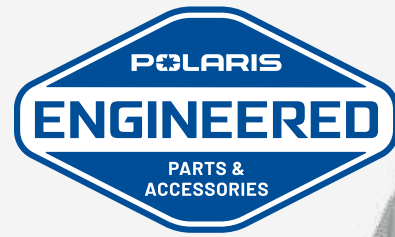

POLARIS ENGINEERED PARTS AND OIL

have been validated and tested extensively, specifically for your vehicle. In order to maintain the peak performance of your Polaris vehicle only use official Polaris Engineered parts and oil.



We're taking the passion of our riders, workers, and outdoor enthusiasts to the next level with HD Parts. These Heavy Duty parts are engineered for riders who want greater durability and enhanced performance. HD Parts are designed and tested to handle greater wear and tear under all weather conditions.



A DRIVE BELT
» 3211186
» **HD** • 3212358



B BRAKE PADS
» FRONT • 2209963
» REAR • 2209964



C OIL FILTER
» 2540086
» **HD** • 2522498



D BATTERY
» 4014132-P
» **HD** • 4081855



E AIR FILTER
» 7083080



F SPARK PLUG
» 3022662

LOOKING FOR MORE SERVICE PARTS?

See P. 65 to learn how to find parts for your model.



G ENGINE OIL P. 60
» PS-4 • .95 L • 2876244
» PS-4 • 3.8 L • 2876245
» PS-4 EXTREME • .95 L • 2889395
» PS-4 EXTREME • 3.8 L • 2889396



H DEMAND DRIVE FLUID
» .95 L • 2877922
» 9.5 L • 2877923



I AGL
» .95 L • 2878068
» 3.8 L • 2878069
» EXTREME • .95 L • 2891028



J DOT 4 BRAKE FLUID
» 355 ML • 2872189

MAINTENANCE MADE EASY



OIL CHANGE KITS

2.4 L Engine Oil (Oil varies by kit), 1 Oil Filter (2540086) & 1 Drain Plug Washer
» PS-4 • 2879323
» PS-4 EXTREME • 2890057



ALL-SEASON GREASE TUBE
» 89 mL • 2871322
» 414 mL • 2871423

MAINTENANCE SCHEDULE*

Claims made based off testing and performance of Polaris HD Parts against standard OEM parts made by Polaris and competitor brands under normal use. For more information regarding Polaris HD parts including vehicle compatibility, installation and maintenance, please contact your authorized Polaris ORV dealer.

BREAK-IN MAINTENANCE

FIRST 25 HRS / 1 MONTH | 500 MI / 800 KM

ENGINE OIL & OIL FILTER CHANGE

TRANSMISSION & FRONT GEARCASE REPLACE FLUIDS

DRIVE BELT INSPECT REPLACE AS NEEDED

12 MONTHS

50 HRS | 1,000 MI / 1,600 KM

ENGINE OIL & OIL FILTER CHANGE

DRIVE BELT INSPECT REPLACE AS NEEDED

AIR FILTER INSPECT REPLACE AS NEEDED

GENERAL LUBRICATION ALL FITTINGS, PIVOTS, CABLES, ETC

BATTERY TEST & CLEAN REPLACE AS NEEDED

SPARK PLUGS INSPECT REPLACE AS NEEDED

BRAKE PADS INSPECT REPLACE AS NEEDED

BRAKE FLUID INSPECT FILL AS NEEDED

TRANSMISSION & FRONT GEARCASE REPLACE FLUIDS

24 MONTHS

100 HRS | 2,000 MI / 3,200 KM

ENGINE OIL & OIL FILTER CHANGE

DRIVE BELT INSPECT REPLACE AS NEEDED

AIR FILTER INSPECT REPLACE AS NEEDED

GENERAL LUBRICATION ALL FITTINGS, PIVOTS, CABLES, ETC

BATTERY TEST & CLEAN REPLACE AS NEEDED

SPARK PLUGS INSPECT REPLACE AS NEEDED

BRAKE PADS INSPECT REPLACE AS NEEDED

BRAKE FLUID CHANGE

TRANSMISSION & FRONT GEARCASE REPLACE FLUIDS

36 MONTHS

150 HRS | 3,000 MI / 4,800 KM

ENGINE OIL & OIL FILTER CHANGE

DRIVE BELT INSPECT REPLACE AS NEEDED

AIR FILTER INSPECT REPLACE AS NEEDED

GENERAL LUBRICATION ALL FITTINGS, PIVOTS, CABLES, ETC

BATTERY TEST & CLEAN REPLACE AS NEEDED

SPARK PLUGS INSPECT REPLACE AS NEEDED

BRAKE PADS INSPECT REPLACE AS NEEDED

BRAKE FLUID INSPECT FILL AS NEEDED

TRANSMISSION & FRONT GEARCASE REPLACE FLUIDS

FOR A COMPLETE MAINTENANCE SCHEDULE, CHECK YOUR OWNER'S MANUAL

OIL & LUBRICANTS

Our PS-4 engine oils provide ultimate performance and protection, they're formulated with exclusive additives to keep engines clean from deposit buildup. These powersports-grade full synthetic oils helps maximize power and protect your engine for the long term.

PS-4 FORMULATIONS BEST PROTECTION, BEST PERFORMANCE



PS-4 5W-50 FULL-SYNTHETIC OIL

Optimal for ambient operating temperatures of -40° C to 38° C.

.95 L 2876244	3.8 L 2876245	60.6 L 2876247	208 L Drum 2876246	1249 L Tote 2878814
------------------	------------------	-------------------	-----------------------	------------------------

PS-4 0W-50 EXTREME FULL-SYNTHETIC OIL

Optimal for ambient operating temperatures of -43° C to 54° C.

.95 L 2889395	3.8 L 2889396	60.6 L 2889397	208 L Drum 2889398	1,249 L Tote 2889399
------------------	------------------	-------------------	-----------------------	-------------------------



PS-4 EXTREME SYNTHETIC 0W-50

- Our best extreme high and low temp formula, excellent for high temperatures and racing, even at temps of 54°C, plus easier cold starting even below -42°C
- Expect the best in wear protection thanks to premium PAO and ester base stocks combined with a balance of moly and ZDDP additives
- Polaris exclusive clean engine additive system reduces deposits and carbon build-up for peak performance and power

THE BEST PROTECTION, MAXIMUM PERFORMANCE

- Powersports grade full synthetics provide long lasting engine protection
- At least 40% improved wear protection compared to all aftermarket oils tested (see engine wear test chart)
- Polaris exclusive clean additive system
- At least 50% less deposits than all aftermarket oils tested (see deposit test chart)
- Cleaner engine with less deposits means consistent maximum power and performance

WIDEST VISCOSITY FOR ULTIMATE PROTECTION



ENGINE WEAR TEST

LOWER NUMBER = LESS ENGINE COMPONENT WEAR
LESS WEAR ON PARTS MEANS LONGER ENGINE LIFE

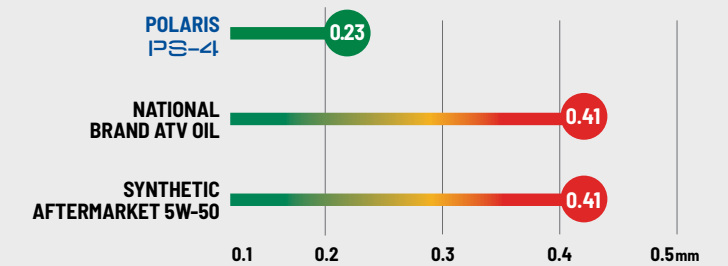

ASTM D4172. In 3rd party testing against 9 competitive products Polaris had 40% or better wear protection compared to all of the tested products. Numbers represent mm of wear scarring measured. Test measures wear at contact points, wear scar is measured for its length and width (in units of mm). Lower wear numbers mean better wear protection and friction reduction.

DEPOSIT TEST

LOWER DEPOSITS = MAXIMUM POWER

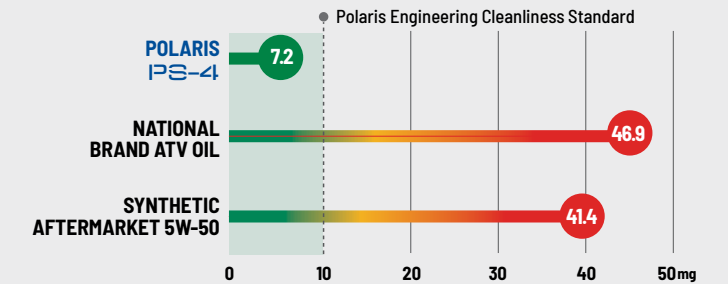

ASTM D6335. In 3rd party testing against 9 competitive products Polaris PS-4 had less than half the deposits compared to the next closest product. No other tested products met Polaris Engineering standards for deposit cleanliness. Test measures mass of deposits in mg in high temp, high stress test cycles. Higher deposits will impact engine power and performance.

OIL CHANGE KITS

These convenient kits include everything needed including filter and oil volume per vehicle

PART NUMBER	VEHICLE FITMENT	PART NUMBER
2890882	RANGER XD 1500	2890883
2202166	RANGER/RZR/SPORTSMAN 570, TWIN 600, TWIN 700, TWIN 800	2890056
2879323	RANGER, GENERAL 900-1000, RZR 900-1000, RS1, POLARIS XPEDITION	2890057
2877473	RANGER/SPORTSMAN 300-500, SPORTSMAN/SCRAMBLER 500/850/1000	2890055
2881696	RZR TURBO (NON PRO R)	2890058
2890880	RZR PRO R	2890881

POLARIS INVESTS IN EACH OIL AT & ABOVE THESE LEVELS

12+ DEDICATED
TEAM MEMBERS
FOCUSED ON POLARIS OIL

18+ MONTHS
DEVELOPMENT & TESTING

76,000+ HOURS
DYNO TESTING

3.5 MILLION+ KILOMETERS
FIELD TESTING



DOT 4 BRAKE FLUID

A high-quality brake fluid designed for use in Polaris hydraulic brakes.
» 355 ML • 2872189



SUSPENSION/ U-JOINT GREASE

» 89 ML • 2871515
» 414 ML • 2871551



GAS SHOCK OIL

» .95 L RACING • 2874124
WALKER EVANS RACING REBUILDABLE SHOCKS
» .95 L PREMIUM • 2870995
FOX REBUILDABLE SHOCKS



AGI

Protects transmission components against wear, corrosion, oxidation and foam in transmissions.
» .95 L • 2878068
» 3.8 L • 2878069
» EXTREME • .95 L • 2891028



DEMAND DRIVE FLUID

Proprietary formulation prevents clutch slippage and chatter and reduces component wear and corrosion.
» .95 L • 2877922
» 9.5 L • 2877923



ANTI-FREEZE

Prevent corrosion on metal components, eliminate scaling and maximize cooling system performance.
» .95 L • 2880514
» 3.8 L • 2880513
» 208 L • 2880512



CARBON CLEAN

Ultimate fuel and injection system cleaner.
» 355 ML • 2881413



ADVANCED FUEL TREATMENT

Dual antioxidant formula protects jets and fuel system from gum and varnish.
» 355 ML • 2881416

GARAGE ACCESSORIES



NEW PARTS TRAY CABINET

- Roller bearing design
- 20.5" W x 16.75" D x 14.75" H
- » PARTS TRAY CABINET W/ 4 DRAWERS • 2830605
- » SQUARE DIVIDERS (24 COMPARTMENTS) • 2830606
- » ADJUSTABLE DIVIDER • 2830607
- » CABINET STAND • 2830608
- » CABINET WITHOUT DRAWERS • 2830609



BATTERY OPERATED FLUID TRANSFER PUMP

- Liquid transfer pumps 5-6 quarts/min suctioning power
- Powered by two 'D' batteries (not included)
- » 2830513



FLUID FUNNEL

- Narrow spout for controlled pouring
- Designed to prevent overfills
- Durable for all types of chemical exposure
- » 2830552



FUNNELS

- Narrow spout for controlled pouring
- Designed to prevent overfills
- Durable for all types of chemical exposure
- » 1.2 L BLUE • 2830574
- » 1.4 L RED • 2830575
- » 1.4 L GREEN • 2830576



NEW EXTENSION CORDS

- Light-up cords designed for extreme cold and heat
- » HD XD 15.2M TRIPLE OUTLET 1 1/2" • 2830587
- » 7.6M SINGLE OUTLET 1 1/2" • 2830588
- » 15.2M SINGLE OUTLET 1 1/2" • 2830589
- » .6M TRIPLE END 1 1/2" • 2830603
- » .6M ADAPTER 30A TO 20A 1 1/2" • 2830602



FLEXIBLE CLUTCH COVER TOOL

- Set includes:
- (1) 1/4" drive x 11" flexible driver
- (1) 1/4" Drive double sided socket - 1/2" x 8mm
- Rubber grip handle and flexible shaft for better leverage
- » 2830572



FLUID SYRINGE

- Easily add and remove fluid from your vehicle
- » 2830553



GREASE GUN

- For 4 1/4 ML All-Season & U-Joint
- Heavy-duty, one-handed pistol grip
- 5,000 PSI, with a 4" steel extension efficiently lubricates, reduces friction and wear and tear
- » 414 ml • 2830569



BATTERY OPERATED FLUID TRANSFER PUMP WITH FLOW CONTROL NOZZLE

- Ideal for quick transfer of fluid, diesel, DEF/Adblue, water & water-based media
- Handheld flow control nozzle
- Powered by two 'D' batteries (not included)
- » 2830595



FLEX SPOUT

- Fits all Polaris quart, gallon and 2.5 gallon bottles
- » 2871285



FLUID CHANGE TRAY

- 22" x 22" x 11.5"
- Chemical and heat resistant
- Holds up to 2 gallons of liquid
- » 2830551



GREASE GUN

- For 88.7 ML All-Season & U-Joint
- Tough steel construction
- Accepts both 8" rigid pip nozzle and 12" 12,000 PSI flex hose
- Enables easy application of grease
- » 88.7 ml • 2871312



HANDHELD PUMP SPRAYER

- Half gallon portable sprayer
- Lightweight and easy to use
- » 2830570



PREMIUM MAINTENANCE TOOL KIT

- Includes 51 pieces
- » 2830565



POLARIS LED POCKET FLASHLIGHT

- Powerful beam - extends 200'
- Powered by 2 AAA batteries
- 90 lumens, 1 watt, energy efficient light
- » 2830436



PUMP

- Fits 1 and 2.5 gallon bottles
- » 2870465



WORK LIGHT - 550 LUMENS

- UV and dual-charging on a 360° rotating swivel
- » 2830584



OIL CHANGE KIT

- 6.5 QT drain pan, one pint oil funnel with screen, oil filter wrench, 15" x 18" absorbent pads (2), clean up wipe (1), 6 mil nitrile gloves (1 pair), blue interfold shop towels (4)
- » 2830545



POLARIS HEAVY-DUTY SCRUBBER WIPES

- » 90 CT • 2830441



POLARIS MAGNETIC PARTS TRAY

- » 2830432



TRAIL TECH PORTABLE AIR COMPRESSOR

- Handheld air compressor with Li-ion battery
- Programmable PSI pressure settings, LED light and USB phone charger
- » COMPRESSOR • 060-DAP
- » CASE • 060-BAG
- » 15" EXTENDER HOSE • 060-LHS



WORK LIGHT - 1000 LUMENS

- Adjustable with magnetic ends
- Battery charge indicator
- » 2830585



OIL FILTER WRENCH - 65MM (2 9/16")

- 14 flute cup size - used with 3/8" square drive
- Works with Polaris Oil Filters 2540086, 2520799 and other 14 flute filters
- » 2830550



POLARIS SHOP TOWELS

- » 200 CT W/ DISPENSER • 2830402
- » 200 CT REFILL • 2830403
- » 64 CT REFILL • 2830440



POLARIS 8.4 cm TELESCOPIC MAGNET

- Retrieve fasteners or parts dropped in hard-to-reach places
- 5 LBS of holding strength
- Extends from 6.5" to 33"
- » 2830435



FOLDING WORK LIGHT - 2000 LUMENS

- Rechargeable light with 2 LED light heads and 360° magnetic swivel handle that functions as a stand
- » 2830591



WORK LIGHT - 4000 LUMENS

- 90° swivel LED light with magnetic backing
- 16', 14 gauge extension cord cable reel
- » 2830586

BATTERY CHARGERS



SERVICE PARTS

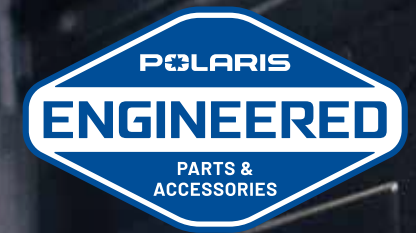

POLARIS ENGINEERED SERVICE PARTS DELIVER UNMATCHED PERFORMANCE AND FIT FOR YOUR OFF-ROAD VEHICLE.

All service parts are engineered specifically for your machine. Which means everything is designed, tested and perfected to maximize the life of your ride. Getting Polaris Engineered parts is a decision that pays off in the long run, because there is a long run.

VISIT YOUR POLARIS DEALER TO SHOP FOR SERVICE PARTS.

MAINTENANCE & GARAGE

MAINTENANCE PARTS & FLUIDS

OIL & LUBRICANTS

GARAGE ACCESSORIES

BATTERY CHARGERS & SERVICE PARTS

POLARIS POWER



NOCO GENIUS® BATTERY CHARGER - 1 AMP

- Keep your battery charged
 - Includes Boost Eyelet Cable with X-Connector Adapter (2830546)
 - Includes adaptor for vehicle charge port
- » 2830567



NOCO GENIUS® BATTERY CHARGER - 2 AMP

- Keep your battery charged
 - Includes Boost Eyelet Cable with X-Connector Adapter (2830546)
 - Includes adaptor for vehicle charge port
- » 2830568



NOCO GENIUS® BATTERY CHARGER - 5 AMP, 2 BANK

- Waterproof charger
 - 5 amps per bank for charging any 12v, AGM, lead-acid and/or lithium-ion batteries
- » 2830599



NOCO GENIUS® BATTERY CHARGER - 10 AMP, 4 BANK

- Waterproof charger
 - 10 amps per bank for charging any 12v, AGM, lead-acid and/or lithium-ion batteries
- » 2830601



NOCO BOOST® GB40 12V 1000A JUMP STARTER

- Delivers 1,000 amps for jump starting a dead battery in seconds
- » 2830547



NOCO BOOST® GB70 12V 2000A JUMP STARTER

- Delivers 2,000 amps for jump starting a dead battery in seconds
- » 2830597



NOCO BOOST® JUMP PACK PROTECTION CASES

- Lightweight, durable and rugged custom exterior
- » GB40 • 2830548
» GB70 • 2830598

YOUR BATTERY IS READY WHEN YOU ARE

FOR THE LIFE OF YOUR RIDE

Maintenance is the key to keeping your Polaris off-road vehicle performing at its peak. Items like belts, lubricants, and batteries represent only a few of these critical items engineered specifically by Polaris.



TESTED, PERFECTED

We test each belt on the intended vehicle - we don't just try to make an existing belt "just work".

- Amery Kuhl, Polaris CVT System Engineer

POLARIS ENGINEERED DRIVE BELTS

OUR INVESTMENT

- 32,187 km of field testing
- Thousands of dyno hours
- 18+ months of development (3,000+ design hours) per belt
- 1,200+ vehicle validation hours
- Collaboration with powertrain & clutch engineers

YOUR ADVANTAGE

- No clutch recalibration
- Less wear & tear due to heat
- Ensure maximum performance of your vehicle
- More time out riding, less time wrenching

OUR INVESTMENTS ENSURE POLARIS BELTS OUTPERFORM YOUR EXPECTATIONS.



TRY THE POLARIS MOBILE APP

COMPATIBLE WITH P2500iEBT & P3200iEBT

- Start & Stop Generator
- Monitor Fuel Level (with Low Fuel Warning), Output Percentage, Total Hours, Power Output
- Monitor Total Run Time Remaining, AC Wattage, AC Voltage, Engine, RPM & Engine Temperature
- Access Service & Owners Manual

P2000i Inverter Generator 2830532



BEST USED FOR

- Tailgating
- Off-Grid
- Camping



Extension Cord Management

P2500iEBT Inverter Generator 2830537



CO
DETECTION
AUTO SHUT-OFF

BEST USED FOR

- Tailgating
- Off-Grid
- Camping



Polaris Mobile/App Compatible for Digital Gauge Readings and Remote Start Features

NEW P3200iEBT Inverter Generator 2830539



CO
DETECTION
AUTO SHUT-OFF

BEST USED FOR

- DIY Remodeling
- One Room Backup
- RV'ing

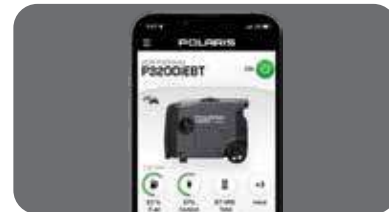

Polaris Mobile/App Compatible for Digital Gauge Readings and Remote Start Features

P5500 / P6500 Open Frame Generator 2830534 / 2830535



BEST USED FOR

- Construction
- Home Backup
- RV'ing



Rough Terrain Wheel

Electric Start

PRESSURE WASHER 3700 2830573



- 3700 psi at 2.5 gpm
- Simpson pro-axial cam pump
- CRX 4-stroke 225cc OHV engine
- Low oil shut-down system
- 10" pneumatic tires
- Heavy-duty steel engine plate
- 1.25" tubular construction
- Professional spray gun
- 35' Morflex® hose
- Thermal relief valve

ELECTRIC PRESSURE WASHER 2500 2830592



- 2500 psi at 1.5 gpm
- 120v electric induction motor
- Axial pump with thermal relief valve
- Detachable cart for easy transport
- Professional spray gun with quick connect nozzles
- 25' Morflex® hose
- 8" Never-flat tires

FEATURED ACCESSORIES



SMALL ENGINE OIL
• 4-cycle engine oil
» 2879383



ALL WEATHER COVER
» P2500iEBT • 2830540
» P3200iEBT • 2830541
» P5500/P6500 • 2830542



**HIGH ALTITUDE
MODIFICATION KIT**
» P2500iEBT • 2889540
» P3200iEBT • 2884866



INVERTER PARALLEL KIT
• Parallel to any two Polaris inverter generators
» 2830536



**BATTERY OPERATED FLUID TRANSFER
PUMP WITH FLOW CONTROL NOZZLE**
» 2830595



TURBO NOZZLE
• 3700 PSI .25" QC turbo nozzle delivers a strong jet of oscillating water that cleans faster than standard nozzles
• Made for reliability and durability, this nozzle is easy to use and great at cleaning hard to remove dirt and debris
» 2830579



POLARIS XPEDITION APPAREL



KEEP CHASING TEE

MEN'S | S-3XL
Dark Gray Heather | 2864751
Olive Heather | 2864752

WOMEN'S | S-3XL
Dark Gray Heather | 2864753



POLARIS XPEDITION ADVENTURE TEE

MEN'S | S-3XL
Heather Gray | 2864756

WOMEN'S | S-3XL
Heather Gray | 2864757

ROSEAU OUTERWEAR



ROSEAU PACKABLE PUFFER JACKET

Packable jacket offers lightweight protection and incredible warmth

MEN'S | S-3XL
Black | 2865315
Olive | 2865316
Blue | 2865317

WOMEN'S | S-3XL
Black | 2865340
Dark Rose | 2865341
Blue | 2865342



ROSEAU QUILTED VEST

Versatile layering with classic puffer styling

MEN'S | S-3XL
Black | 2865323
Olive | 2865324
Rust | 2865325

WOMEN'S | S-3XL
Black | 2865347
Dark Rose | 2865348
Teal | 2865349

APPAREL

FIT FOR ANY ADVENTURE. For outdoor enthusiasts looking for gear that's purposefully built to stand up to the fun and challenging experiences Polaris vehicles enable. Each piece of apparel and equipment bearing the name Polaris is crafted by outdoor enthusiasts, for outdoor enthusiasts. They are a badge of honor – representing what the Polaris brand stands for – a passion to simply be outside doing what you love.

HATS



ELLIPSE PATCH TRUCKER HAT

Purple | 2864563
Cypress | 2864562
Gray | 2833498

Black | 2833500
Navy | 2833499
Orange | 2833124



CORE CAP TOP SELLER

Red | 2833123
Gray | 2833507

Navy | 2833494
Black | 2833495



SHADOW LOGO CAP

Black | 2865519
Olive | 2865520



HALF DOME PATCH CAP

Black | 2864576
Tan | 2864577

CASUALWEAR



NEW
SOFTSHELL JACKET 2.0

MEN'S | S-3XL
Black | 2865318
Rust | 2865319
Blue | 2865320

WOMEN'S | S-3XL
Black | 2865343
Blue | 2865344



NEW
TECH FULL-ZIP HOODIE

MEN'S | S-3XL
Black | 2865507
Olive | 2865508

WOMEN'S | S-3XL
Black | 2865509
Teal | 2865510



NEW
PERFORMANCE SHIRT

MEN'S | S-3XL
Sand | 2865497
Cypress | 2865498



NEW
ODYSSEY HOODIE

MEN'S | S-3XL
Gray | 2865394
Tan | 2865395
Navy | 2865396

WOMEN'S | S-3XL
Dark Blue | 2865398
Dark Rose | 2865399
Gray | 2865397



PLAID FLANNEL SHIRT

MEN'S | S-3XL
NEW Cabernet | 2865495
Blue | 2864671
Cypress | 2864672

WOMEN'S | S-3XL
NEW Cabernet | 2865496
Blue | 2864673
Teal | 2864674



NEW
LIFE OUTSIDE TEE

MEN'S | S-3XL
Faded Red | 2865450
Sage | 2865451
Light Blue | 2865452



NEW
SHADOW LOGO CREW SWEATSHIRT

MEN'S | S-3XL
Black | 2865460
Olive | 2865462



NEW
SCENIC CREWNECK SWEATSHIRT

WOMEN'S | XS-2XL
Charcoal | 2865482
Blush | 2865483
Ivory | 2865484



NEW
EXPLORE OUTDOORS TEE

WOMEN'S | S-3XL
Red Heather | 2865470
Navy Heather | 2865471

HELMETS & GOGGLES



TEAL/LIME
2865411

NEW
509 TACTICAL 3.0 MTN

EXPERIENCE TOP-TIER PROTECTION,
COMFORT AND CONNECTIVITY

XS-4XL
SIZE VARIES BY COLOR
ALSO AVAILABLE IN YOUTH

SHELL

• Poly and ABS polymer construction - ensures both strength and a lightweight feel for maximum protection

WEIGHT

• Starting at 1,300g

FEATURES

- Venturi Vent system generates negative pressure at velocity and pulls moist air from the breath box
- Cardo® UCS Compatibility - integration and easy assembly of Cardo® UCS modules (sold separately)
- Magnetic Fidlock® chin-strap technology
- Plush liner design
- Compatible with VEES Protection System (sold separately) for cold days
- DOT-and ECE 22.06-approved



NEW
MAROON/FUCHSIA
2865435

TENACITY 4.0

COMBINATION OF MODERN STYLE & PREMIUM PROTECTION WITH INCREDIBLE VALUE

XS-2XL

SHELL

• Shock-resistant, injection-molded thermoplastic

WEIGHT

• 1,500g

FEATURES

- Through-flow, full-helmet ventilation
- ProClip quick release chin strap allows you to fasten the chin strap in seconds
- Removable breath box
- Toolless adjustable roost shield
- Removable, washable liner
- DOT- and ECE 22.06-approved



NEW
FUCHSIA/GRAY
2865427

509 KINGPIN

PREMIUM MATERIALS, ATTRACTIVE PRICE

FEATURES

- Built for off-road, the oversized spherical lens delivers optimal peripheral vision
- Metal tear-off posts provide strength and durability
- Quick-change technology allows you to run the best lens tint for conditions



NEW
BLUE
2865431

509 MX6

SUPER WIDE FIELD OF VIEW, ENGINEERED FOR DIRT

FEATURES

- PC outer lens with anti-scratch coating, and internal anti-fog coating
- Outriggers with latch system for quick lens change
- 45mm strap with silicone to hold strap in place



SEE OUR FULL LINE OF HOME & COLLECTIBLES AT YOUR LOCAL DEALER



**KICKBACK
ROCKER**
Green | 2864816
Blue | 2862626



**FOLDABLE
TABLE**
Black | 2861620



NEW
**POLARIS RUMPL®
BLANKET**
2864858



**15 OZ
CAMPFIRE
MUG**
2861613

APPAREL

POLARIS EXPEDITION APPAREL

OUTERWEAR & HATS

CASUALWEAR

HELMETS & GOGGLES

KEEP CHASING THE WILD



POLARIS
Think Outside

Warning: Polaris off-road vehicles can be hazardous to operate and are not designed for on-road use. Driver must be at least 16 years old with a valid driver's license to operate. All riders should always wear helmets, eye protection and footwear. Read, understand and follow your owner's manual. Ride within the limits of your own abilities and never engage in stunt or exhibition driving. Never ride under the influence of drugs or alcohol. All riders should take a safety training course. Call 800-342-3764 for additional information.

Unless noted, trademarks are the property of Polaris Industries Inc. 509® is a registered trademark of Teton Outfitters, LLC. App Store® is a registered trademark of Apple Inc. Bluetooth® is a registered trademark of Bluetooth Sig, Inc. Caliber® is a registered trademark of Caliber, Inc. Cardo® is a registered trademark of Cardo Systems, Inc. CruzTOOLS® is a registered trademark of Cycoactive, Inc. Facebook™ is a service trademark of Facebook, Inc. Fidlock® is a registered trademark of Fidlock GmbH. FOX® is a registered trademark of Fox Factory Inc. GatorStep® is a registered trademark of GatorStep LLC. Google Play™ is a service trademark of Google LLC. Instagram™ is a service trademark of Instagram, LLC. JBL® is a registered trademark of Harman International Industries, Inc. MAXTRAX® is a registered trademark of MAXTRAX Australia Pty Ltd Limited Liability Company. Morflex® is a registered trademark of FNA Group, Inc. NOCO Boost® and NOCO Genius® are registered trademarks of The Noco Company. RAM® is a registered trademark of National Products, Inc. RHINO-RACK® is a registered trademark of Rhino Rack Australia Pty Limited. RIGID® is a trademark of JST Performance, LLC d/b/a Rigid Industries. RUMPL® is a registered trademark of Rumpl, Inc. SMART BOARD® is a registered trademark of SMART Technologies ULC Unlimited Liability Corporation Canada. Tiger Drylac® is a registered trademark of Tiger Coatings GmbH & Co. Twitter™ is a service trademark of Twitter, Inc. Velcro® is a registered trademark of VELCRO IP HOLDINGS LLC. YouTube® is a registered trademark of Google LLC. Prices, Fitment and availability are subject to change at any moment. Copyright © 2024 Polaris Industries Inc. All rights reserved.

Availability varies by market, check your local dealer for availability. Never transport a loaded firearm. Verify firearm is unloaded prior to mounting. Please refer to local laws and regulations regarding the requirements for the legal transport of firearms.

MY25 POLARIS XPEDITION APP ACC INTL